

2J7024Bc

CELLULAR/LTE MIMO

Key Features

Cable 1 - 4: CELLULAR / LTE

Screw Mount

Heavy Duty antenna

High Performance

Ground Plane Independent

Anti-Rotation Mounting

Customizable Cable and Connector

Dimensions: Ø 96 x H 90 mm

Certificates: IP67, IP69, IK09

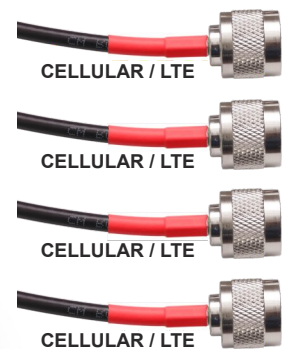

Description

Compact heavy duty antenna designed for 4G LTE suitable for wide range of applications within industry. Antenna is made with specific anti-rotation mounting system. Housing of the antenna is certified for standards of IP67 for water resistance, IK09 for high impact resistance and IP69 standard for high pressure and hot water ingress.



1. Antenna and electrical specifications

Cable 1

Parameters	CELLULAR / LTE Antenna		
Standards	2G,3G and 4G		
Band (MHz)	700/850/900	1700/1800/1900/2100	2600
Frequency (MHz)	698-960	1710-2170	2500-2700
Return Loss (dB)	~-6.5	~-10.9	~-21.3
VSWR	~2.9:1	~1.9:1	~1.3:1
Efficiency (%)	~36	~41	~53
Peak Gain (dBi)	~-0.2	~3.8	~6.0
Average Gain (dB)	~-4.4	~-3.9	~-2.7
Impedance (Ohm)	50		
Polarisation	Linear		
Radiation Pattern	Omni-Directional		
Max. Input Power (W)	25		
Connector Type	SMA-Male Standard (Other Connectors Available)		
Cable Length	300 cm Standard (Any Cable Length Available)		
Cable Type	LMR195 Standard (Other Cables Available)		

Cable 2

Parameters	CELLULAR / LTE Antenna		
Standards	2G,3G and 4G		
Band (MHz)	700/850/900	1700/1800/1900/2100	2600
Frequency (MHz)	698-960	1710-2170	2500-2700
Return Loss (dB)	~-6.6	~-10.0	~-15.4
VSWR	~2.8:1	~2.1:1	~1.4:1
Efficiency (%)	~35	~42	~53
Peak Gain (dBi)	~-0.1	~3.2	~5.6
Average Gain (dB)	~-4.5	~-3.8	~-2.7
Impedance (Ohm)	50		
Polarisation	Linear		
Radiation Pattern	Omni-Directional		
Max. Input Power (W)	25		
Connector Type	SMA-Male Standard (Other Connectors Available)		
Cable Length	300 cm Standard (Any Cable Length Available)		
Cable Type	LMR195 Standard (Other Cables Available)		

Antenna Measurement Conditions:

Mounted on Metal Plate of 30 x 30 cm
 200 cm of LMR195 Cable
 Measured in Certified CTIA 3D Anechoic Chamber

1. Antenna and electrical specifications

Cable 3

Parameters	CELLULAR / LTE Antenna		
Standards	2G,3G and 4G		
Band (MHz)	700/850/900	1700/1800/1900/2100	2600
Frequency (MHz)	698-960	1710-2170	2500-2700
Return Loss (dB)	~-6.4	~-10.4	~-18.9
VSWR	~2.9:1	~2.0:1	~1.4:1
Efficiency (%)	~35	~40	~53
Peak Gain (dBi)	~-0.5	~3.1	~5.0
Average Gain (dB)	~-4.5	~-4.0	~-2.7
Impedance (Ohm)	50		
Polarisation	Linear		
Radiation Pattern	Omni-Directional		
Max. Input Power (W)	25		
Connector Type	SMA-Male Standard (Other Connectors Available)		
Cable Length	300 cm Standard (Any Cable Length Available)		
Cable Type	LMR195 Standard (Other Cables Available)		

Cable 4

Parameters	CELLULAR / LTE Antenna		
Standards	2G,3G and 4G		
Band (MHz)	700/850/900	1700/1800/1900/2100	2600
Frequency (MHz)	698-960	1710-2170	2500-2700
Return Loss (dB)	~-6.7	~-10.4	~-16.3
VSWR	~2.8:1	~2.1:1	~1.4:1
Efficiency (%)	~36	~42	~54
Peak Gain (dBi)	~-0.7	~3.0	~4.8
Average Gain (dB)	~-4.4	~-3.7	~-2.6
Impedance (Ohm)	50		
Polarisation	Linear		
Radiation Pattern	Omni-Directional		
Max. Input Power (W)	25		
Connector Type	SMA-Male Standard (Other Connectors Available)		
Cable Length	300 cm Standard (Any Cable Length Available)		
Cable Type	LMR195 Standard (Other Cables Available)		

Antenna Measurement Conditions:

Mounted on Metal Plate of 30 x 30 cm
 200 cm of LMR195 Cable
 Measured in Certified CTIA 3D Anechoic Chamber

2. Mechanical and environmental specifications

Specifications	2J7024Bc
Mounting Type	Screw Mount
Dimensions (mm)	Ø 96 x H 90
Max. Tighten Torque (Nm)	15 Nm
Radome	ASA UV Stable
Radome color	White, Black
Antenna Base	Alluminium alloy
Operating Temperature (C)	-40 to +85
Storage Temperature (C)	-40 to +85
Substance Compliance	RoHS
Certificates	IP67, IP69, IK09

3. Antenna parameters

Cable 1: CELLULAR/LTE

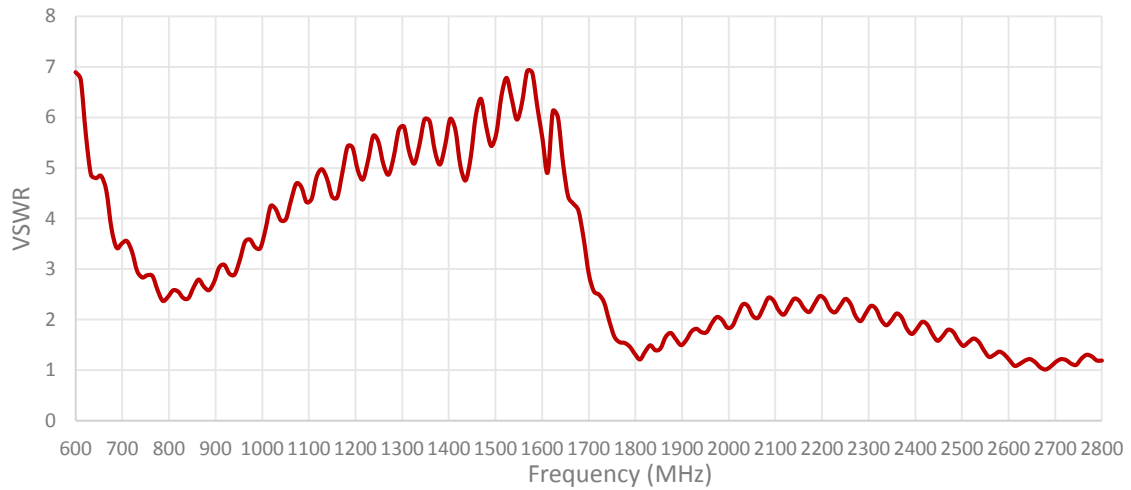
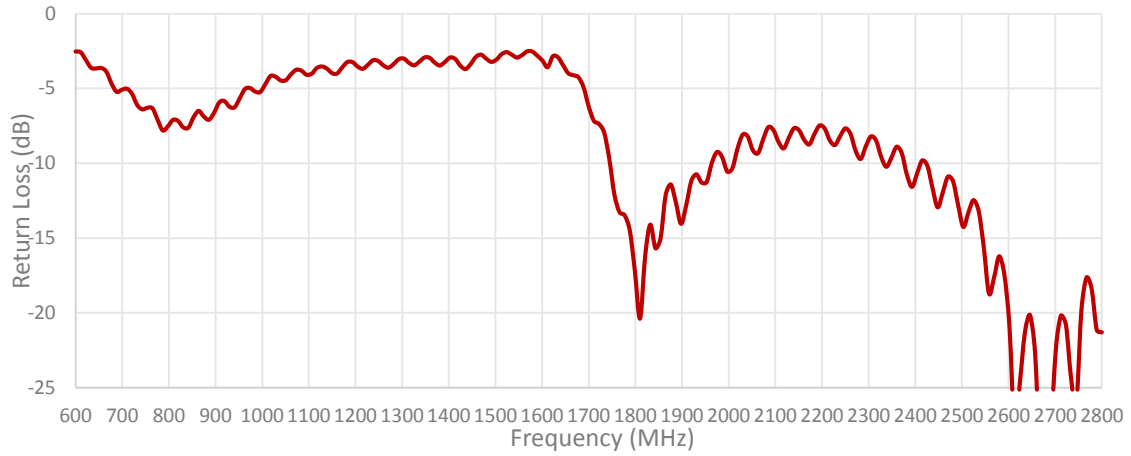

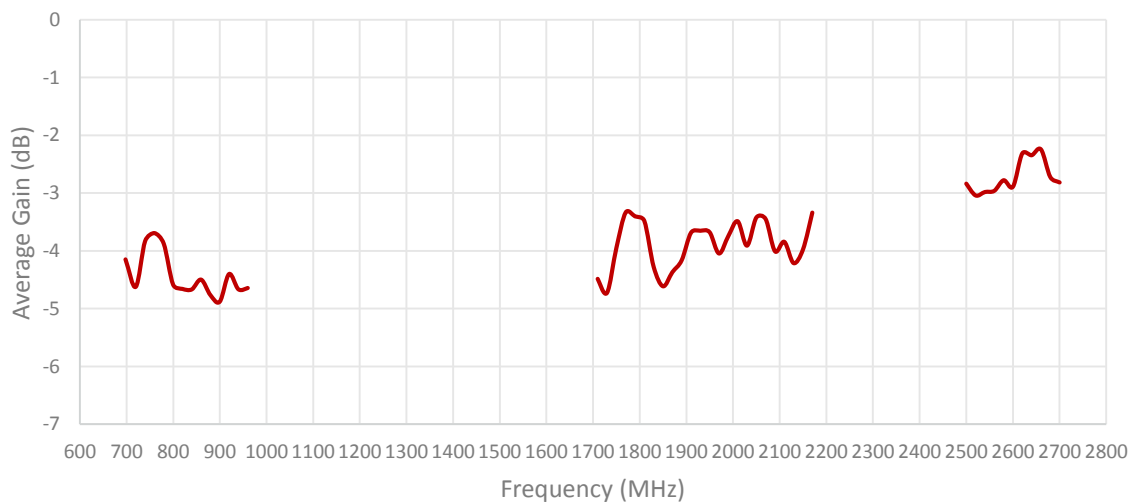
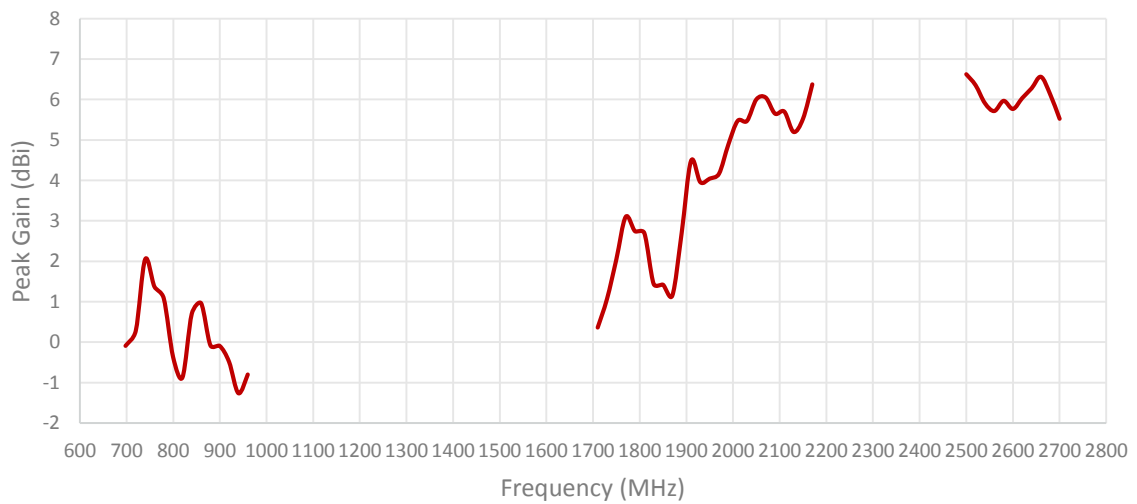
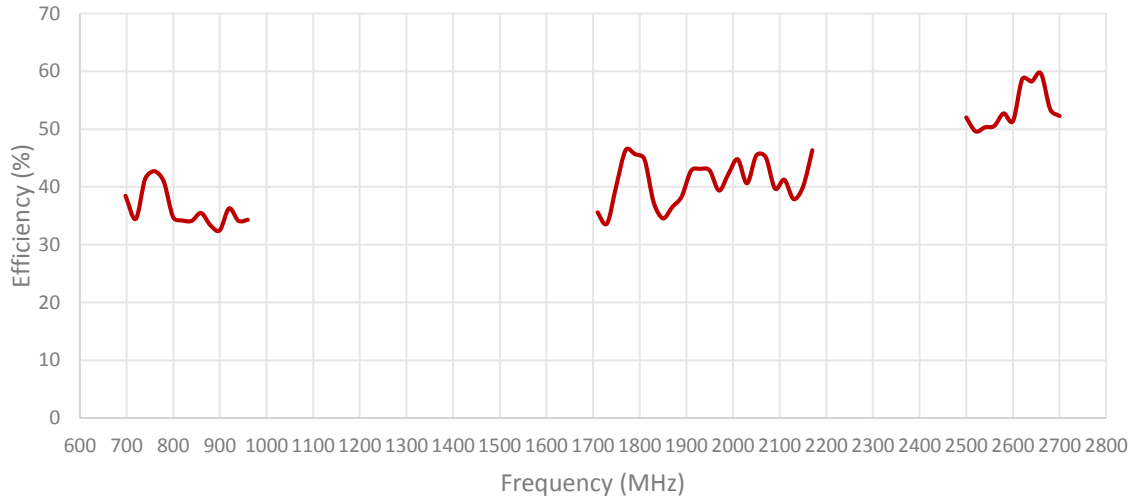
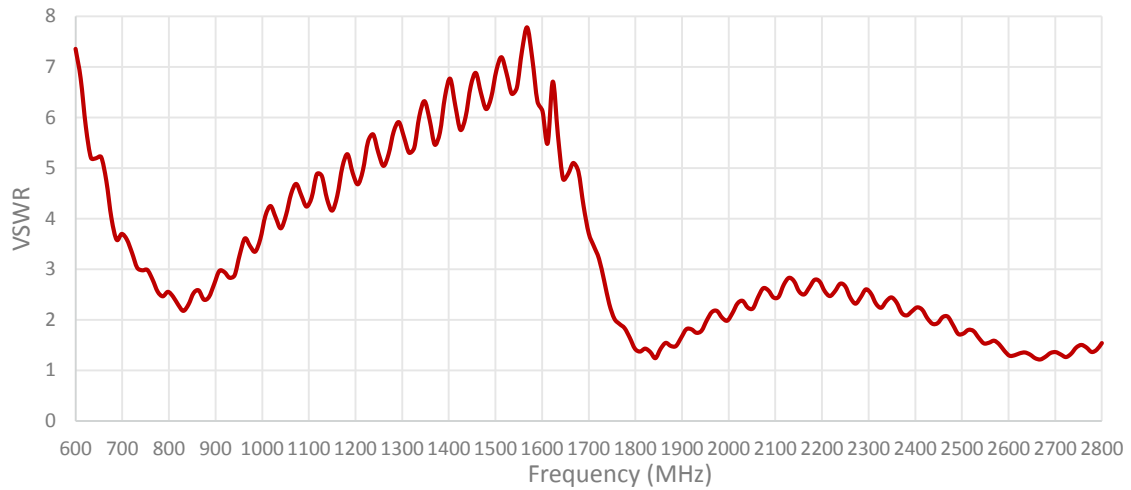
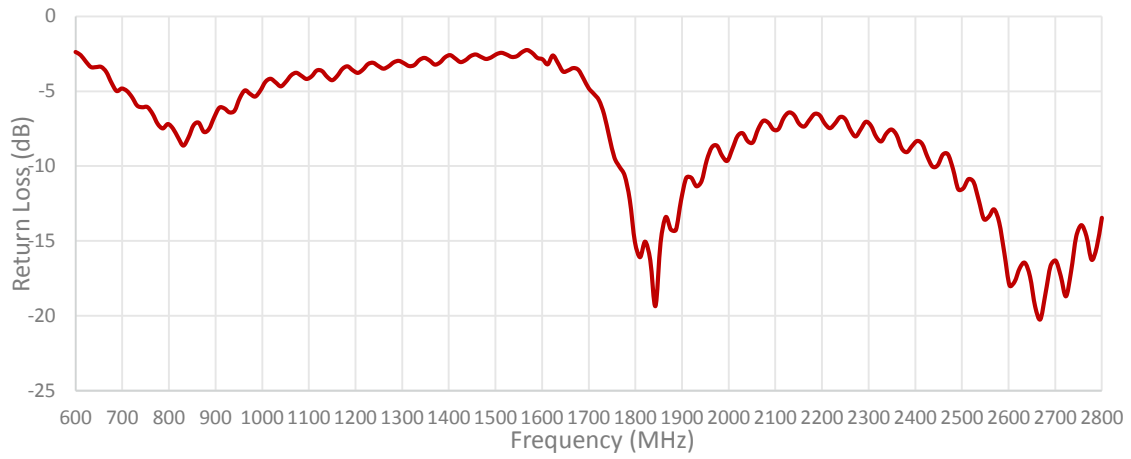

Table 2: CELLULAR/LTE



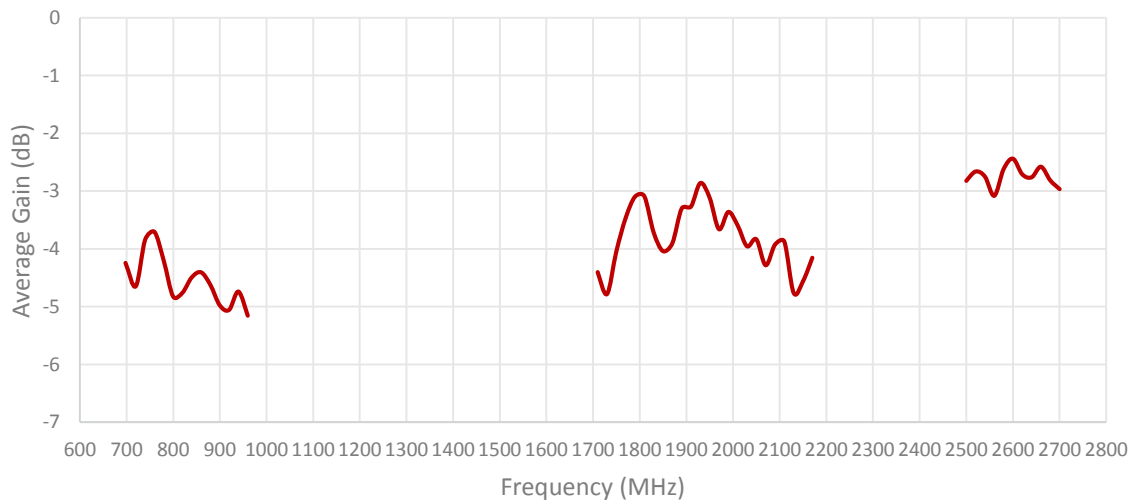
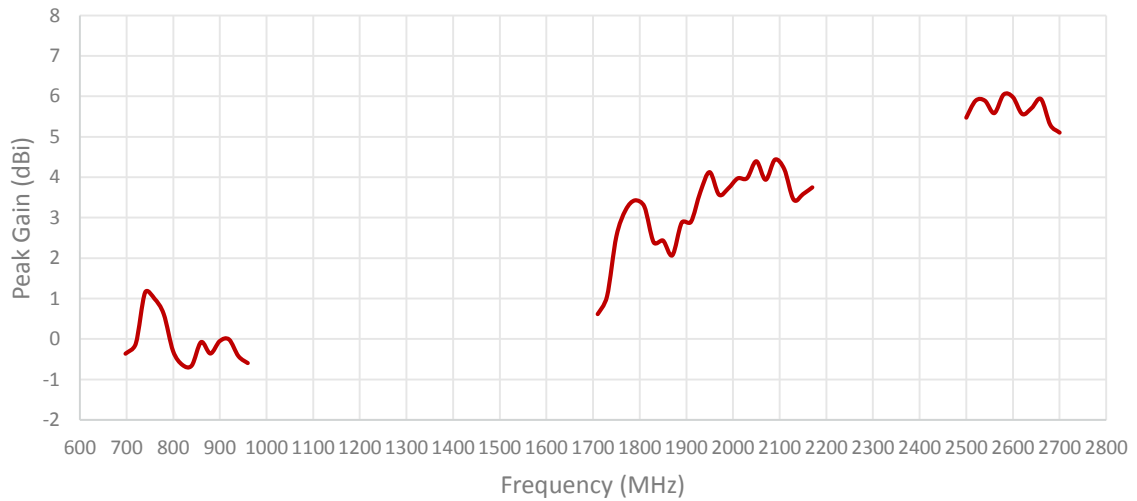
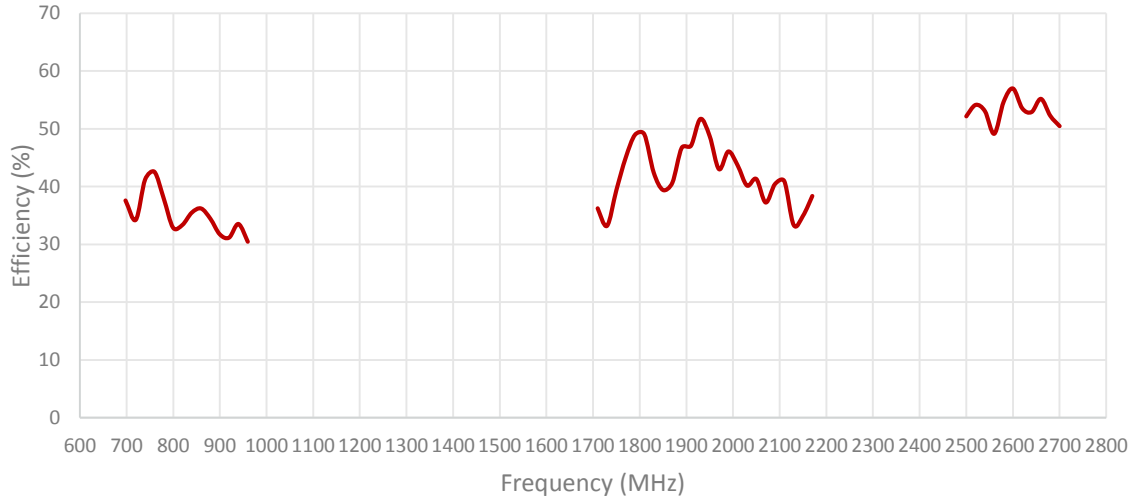
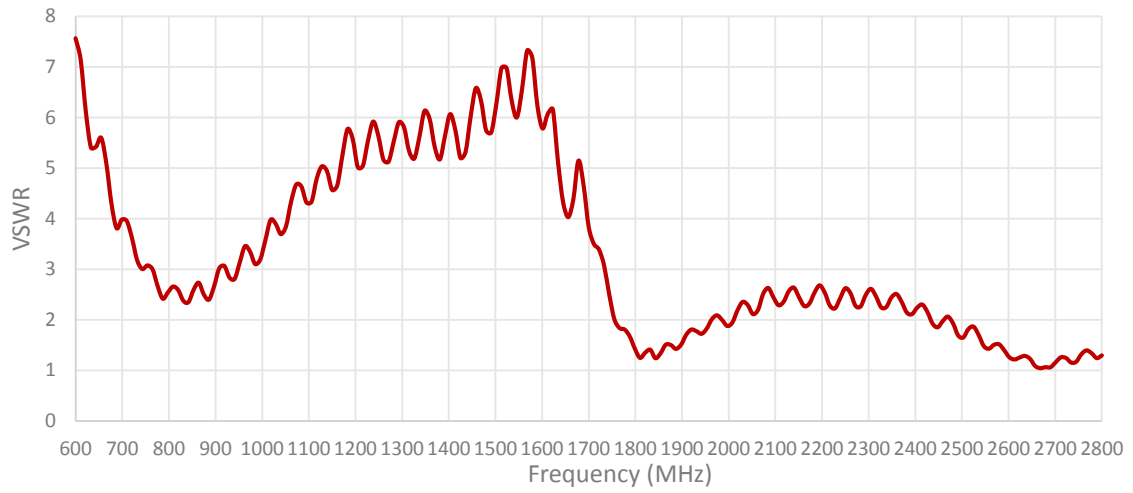
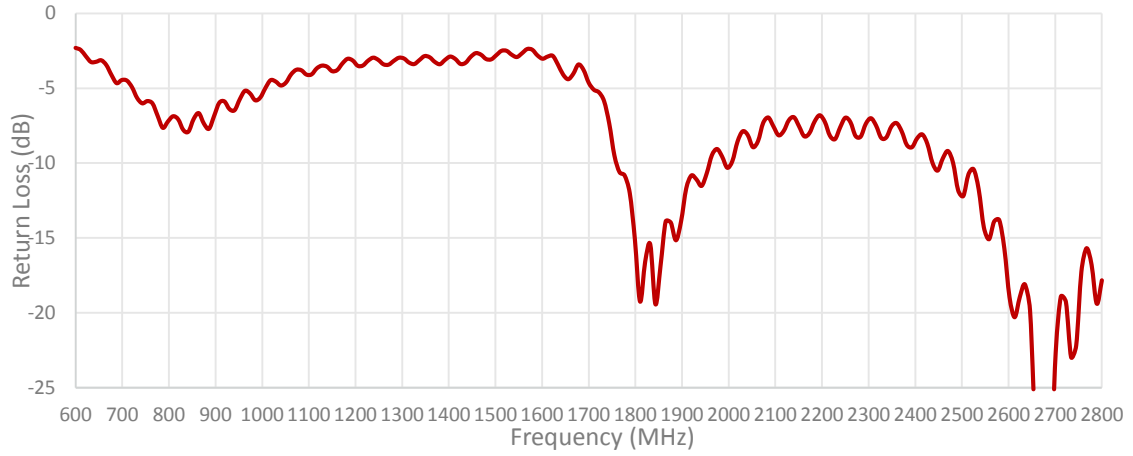

Table 3: CELLULAR/LTE



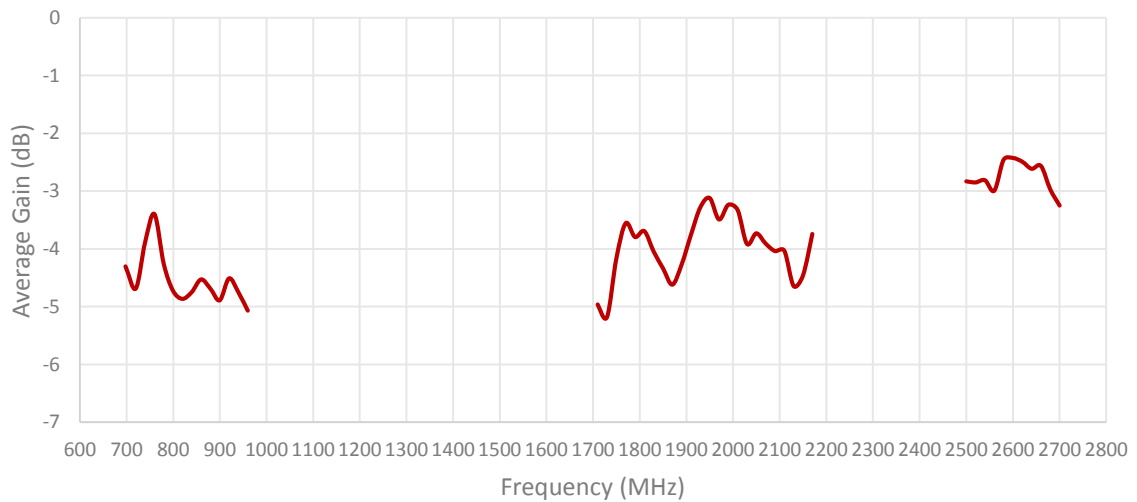
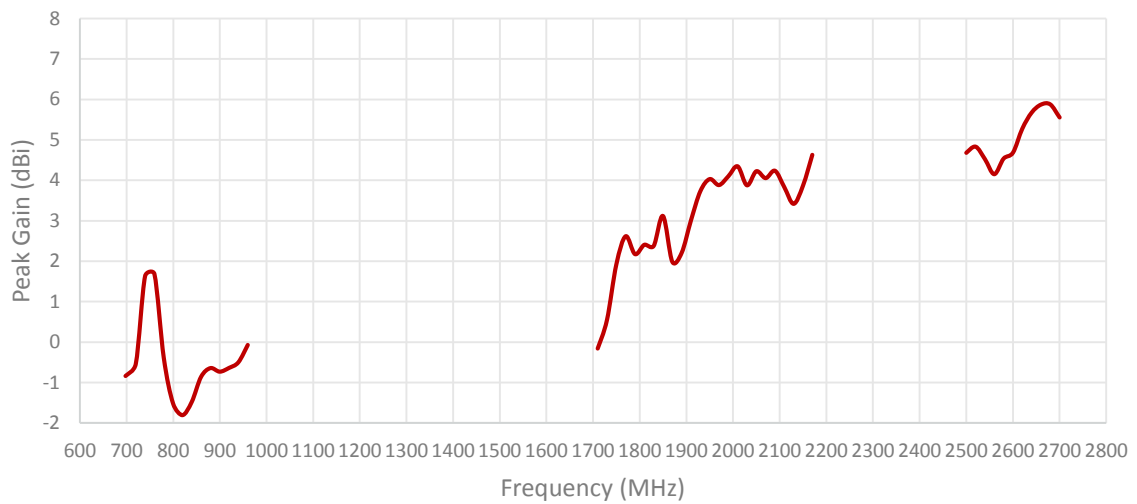
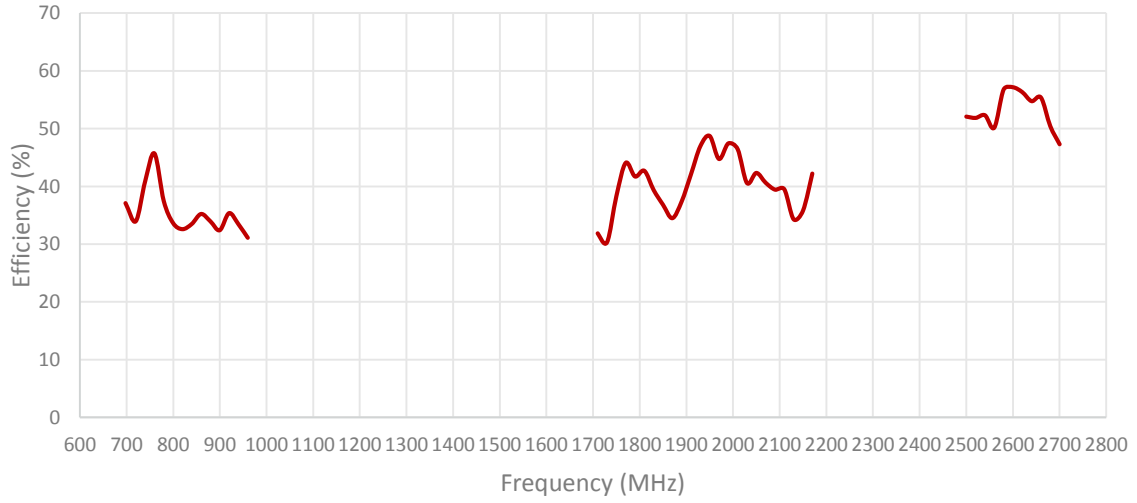
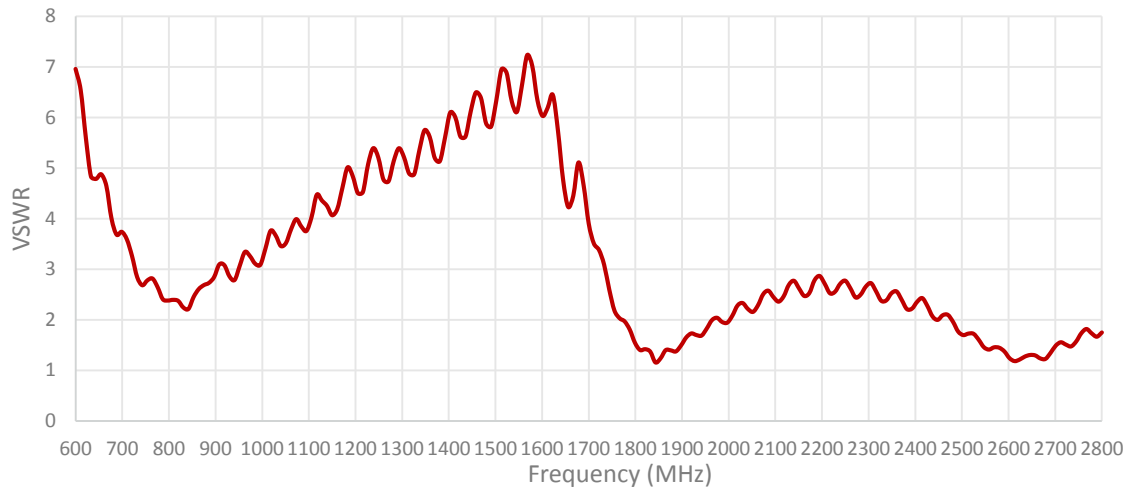
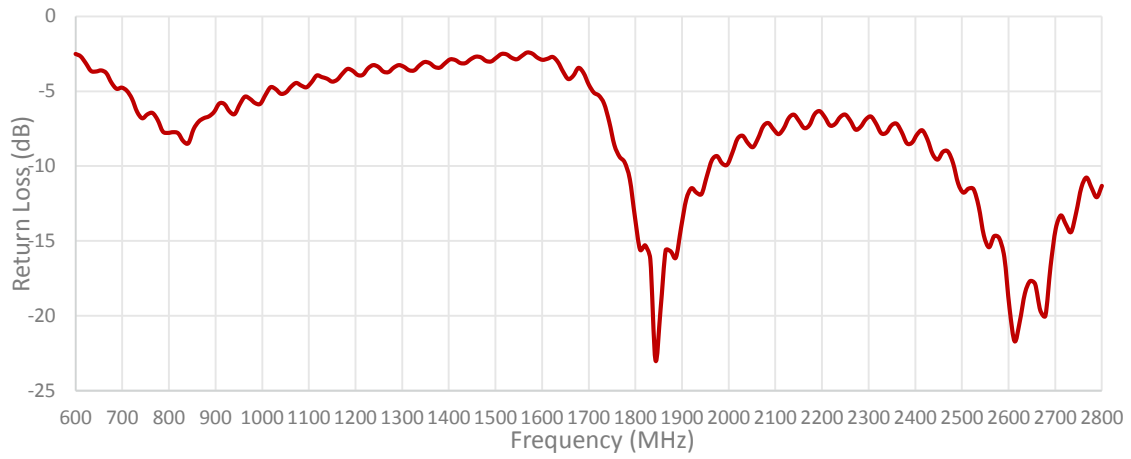
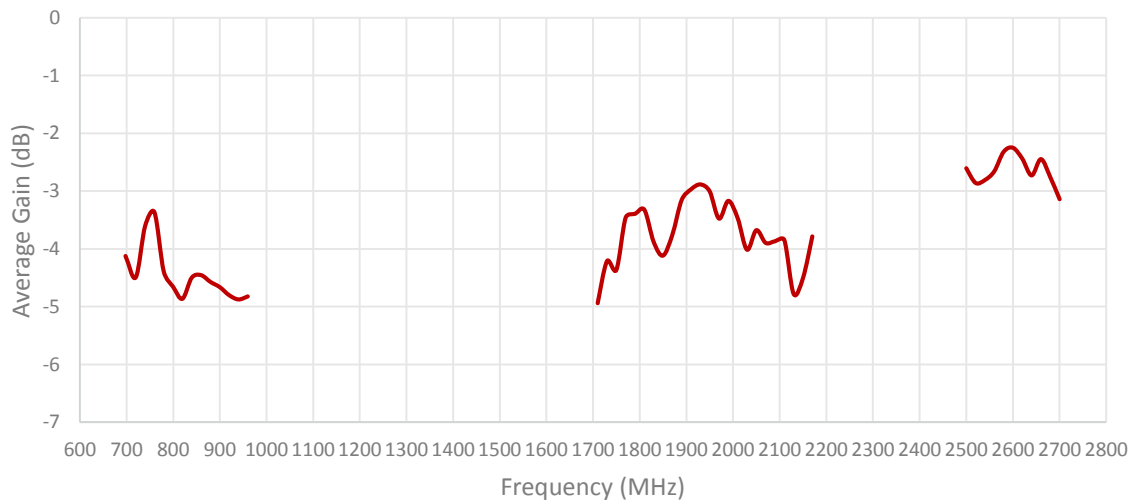
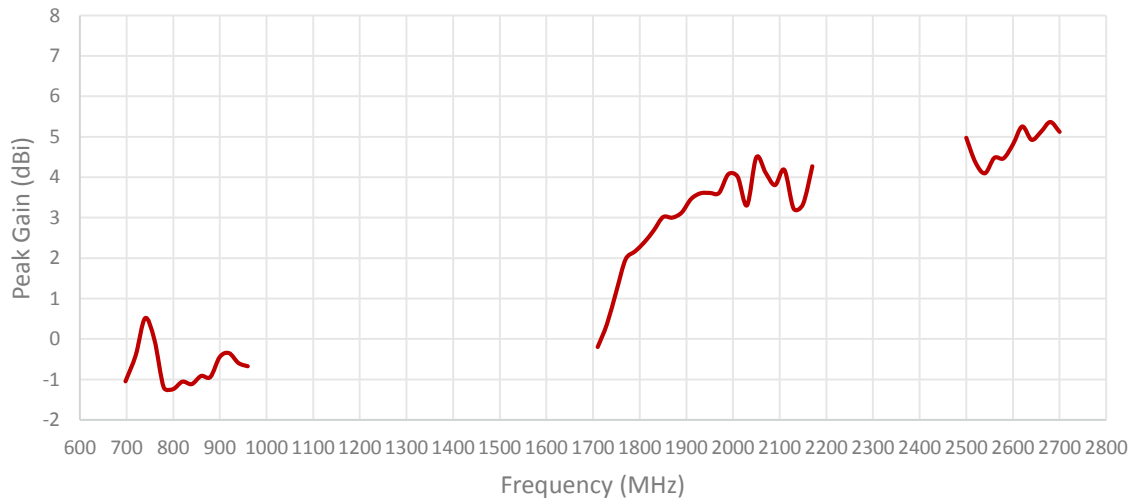
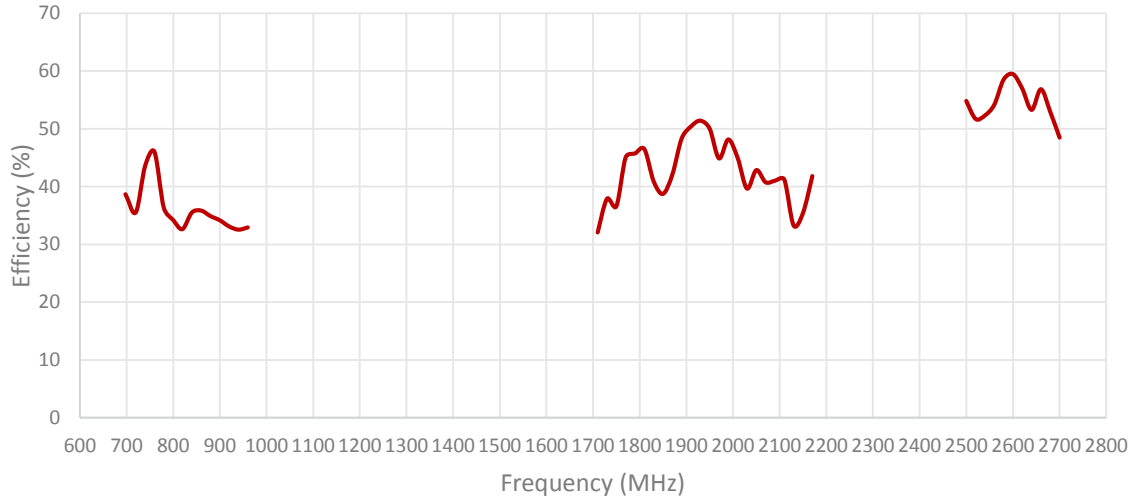
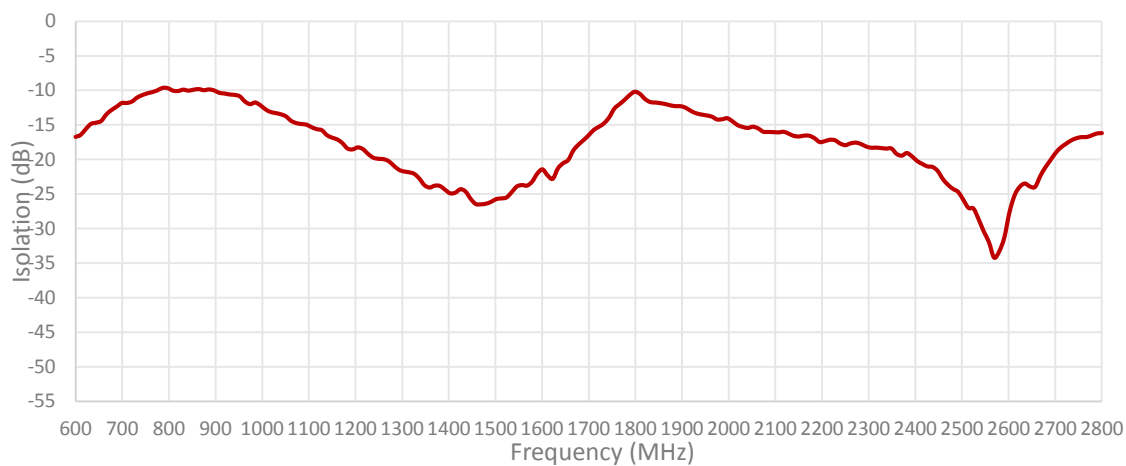

Table 4: CELLULAR/LTE





ISOLATION FOR CABLES 1 AND 3



ENVELOPE CORRELATION COEFFICIENT FOR CABLES 1 AND 3

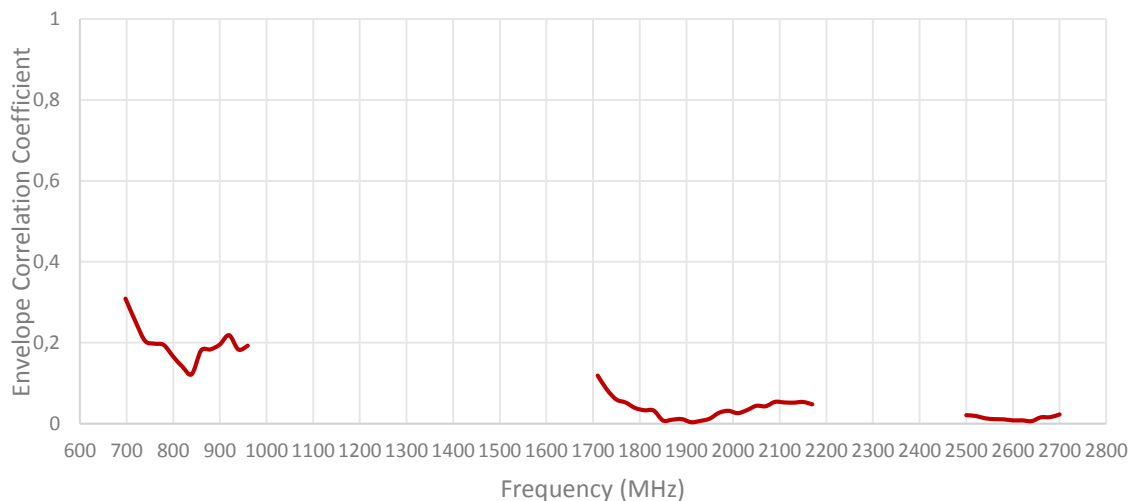

ISOLATION FOR CABLES 3 AND 4

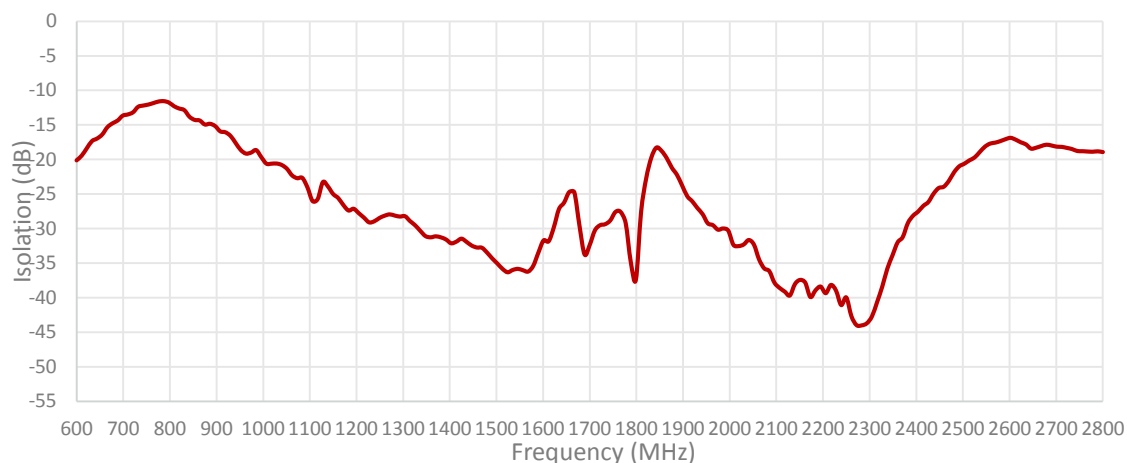

ENVELOPE CORRELATION COEFFICIENT FOR CABLES 3 AND 4

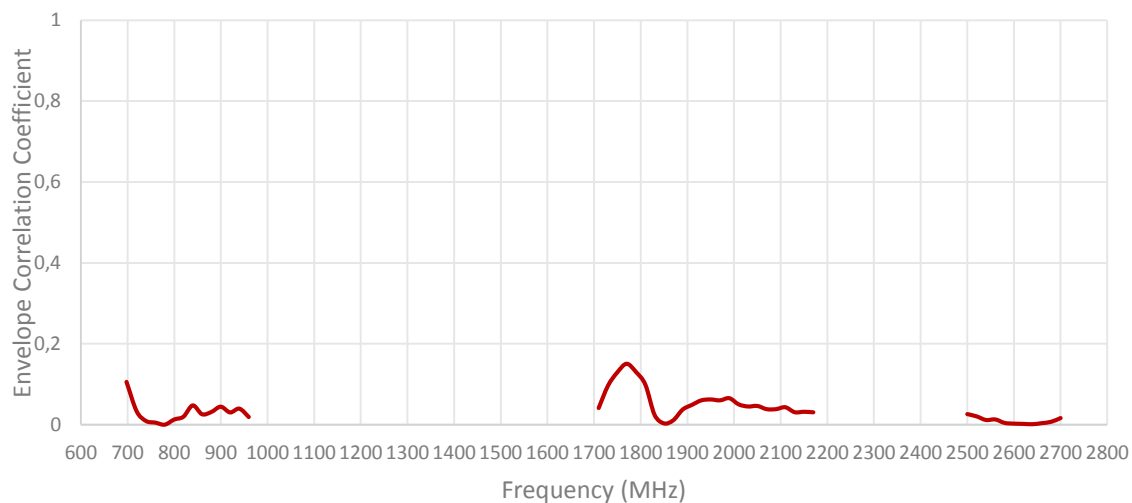

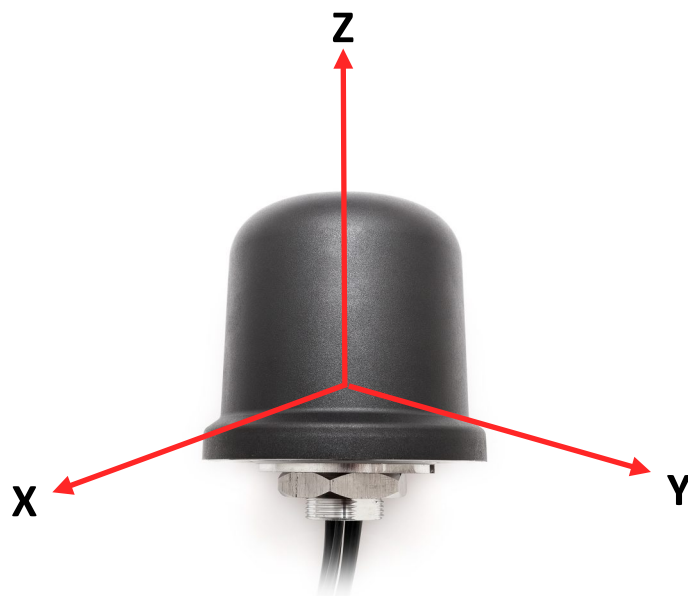

Radiation pattern reference

Cable 1: CELLULAR/LTE

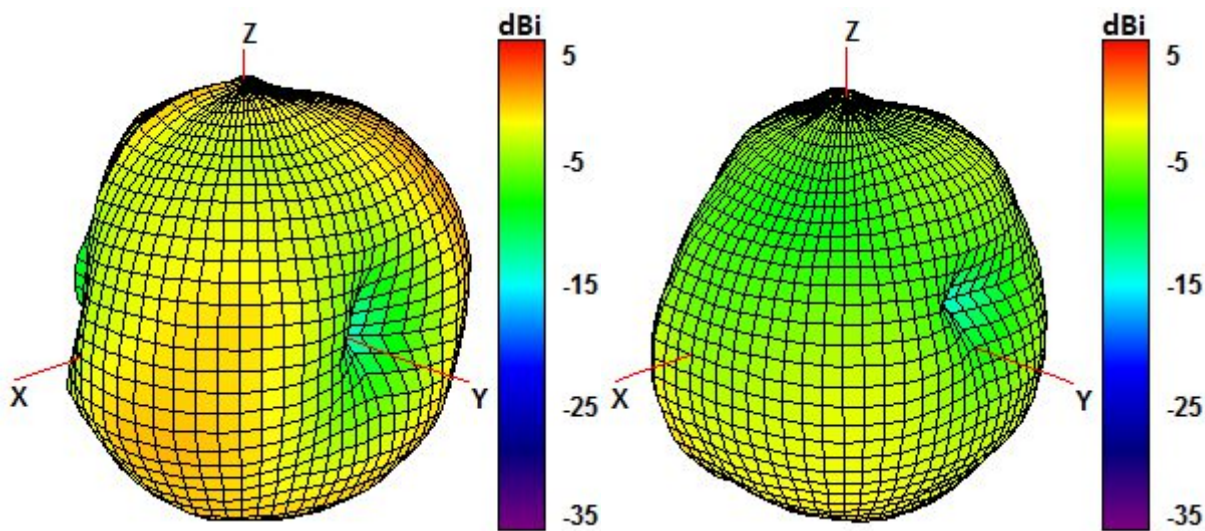

750 and 850 MHz Radiation pattern

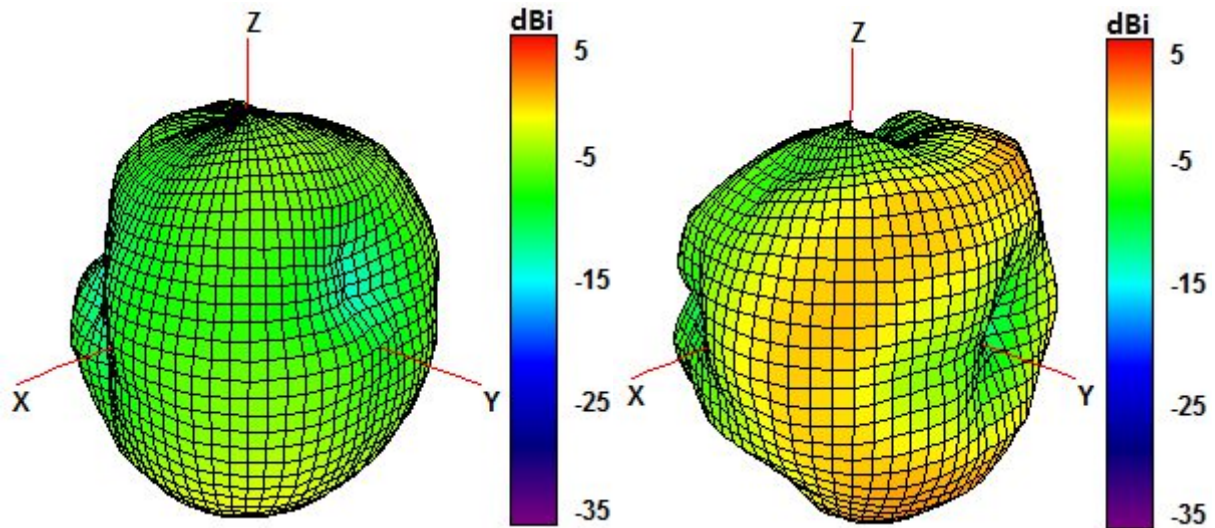

940 and 1750 MHz Radiation pattern

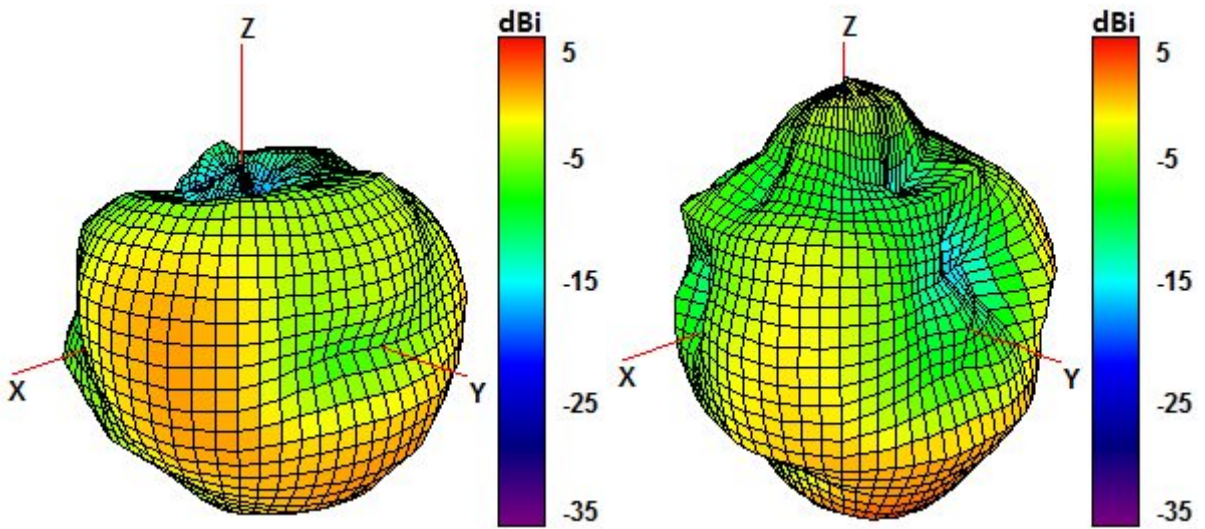

1850 and 1950 MHz Radiation pattern

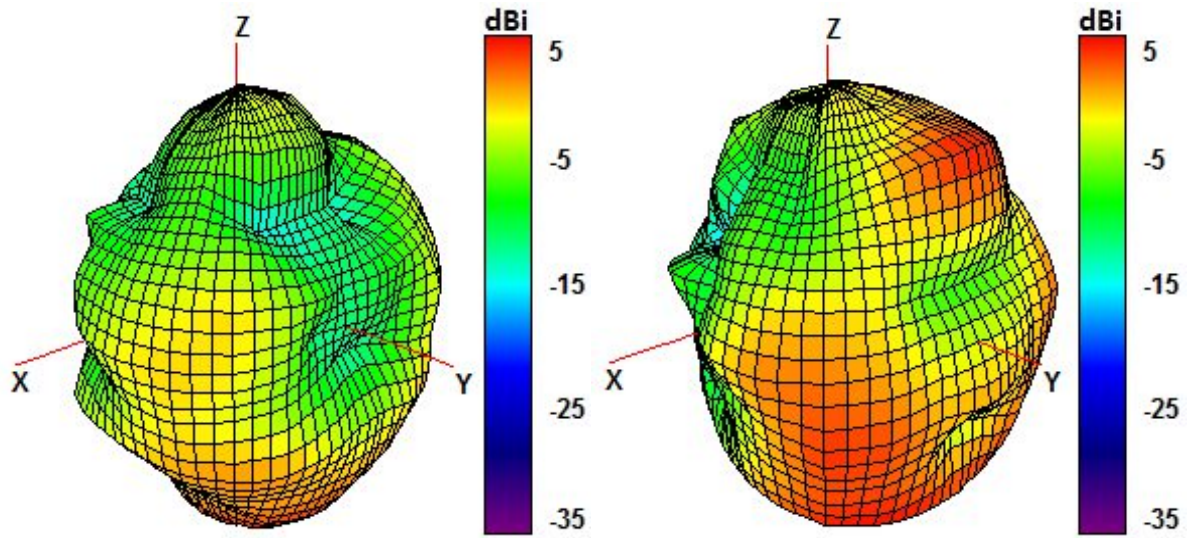

2100 and 2600 MHz Radiation pattern

Table 2: CELLULAR/LTE

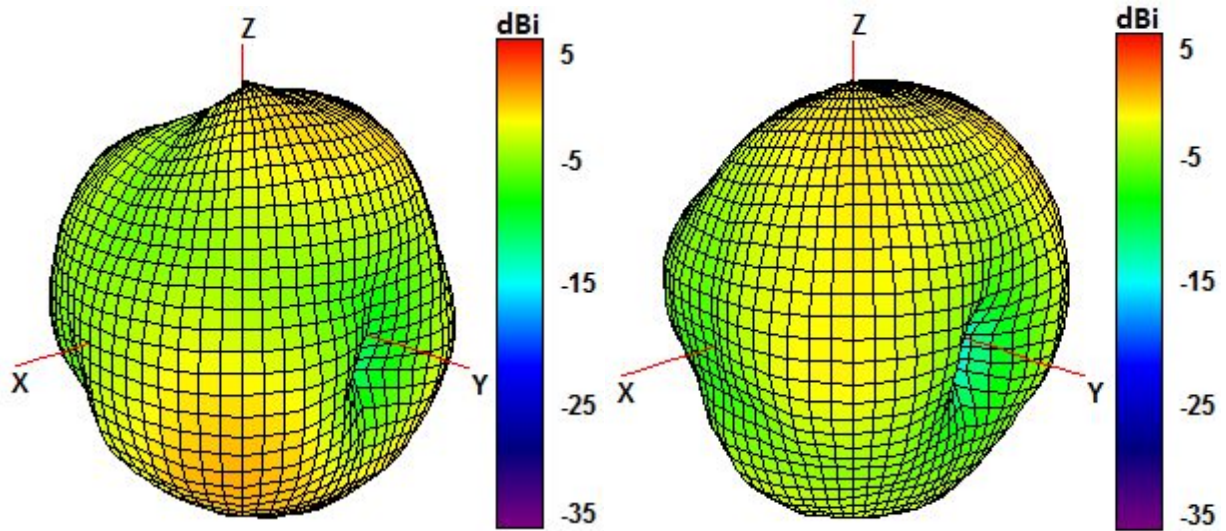

750 and 850 MHz Radiation pattern

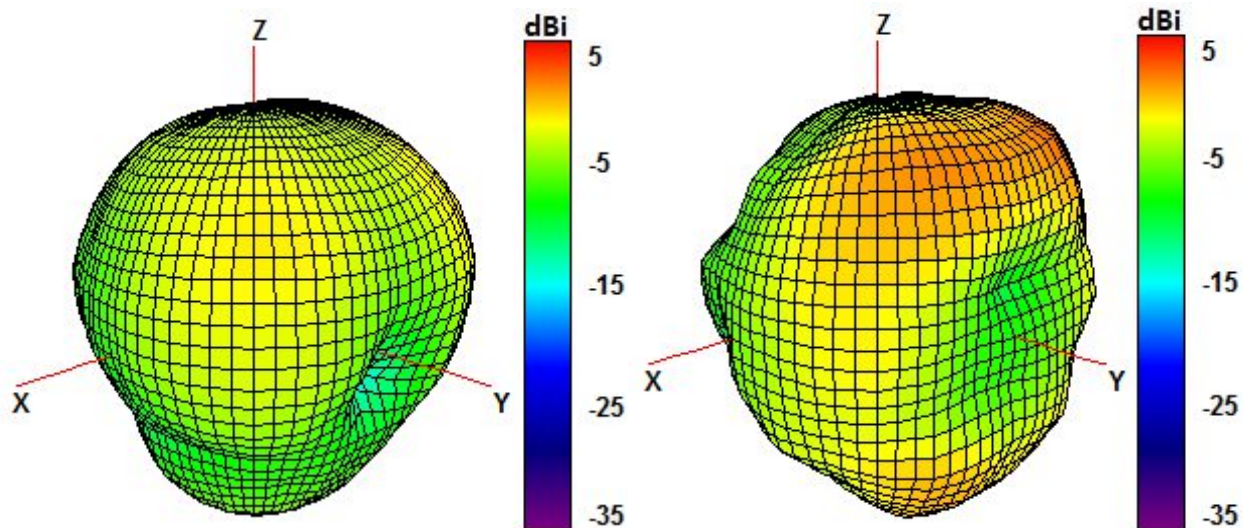

940 and 1750 MHz Radiation pattern

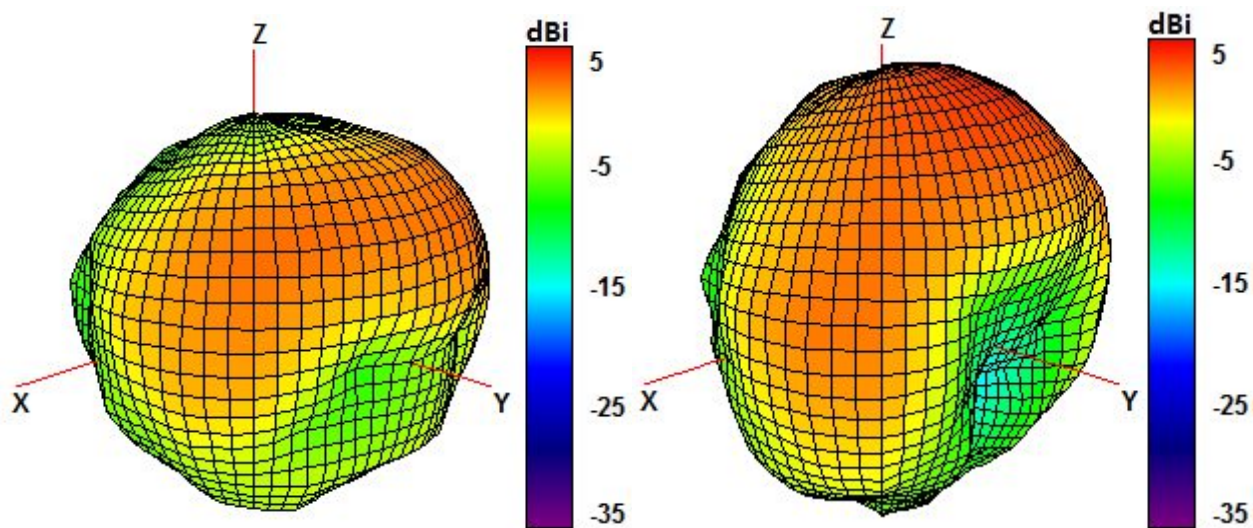

1850 and 1950 MHz Radiation pattern

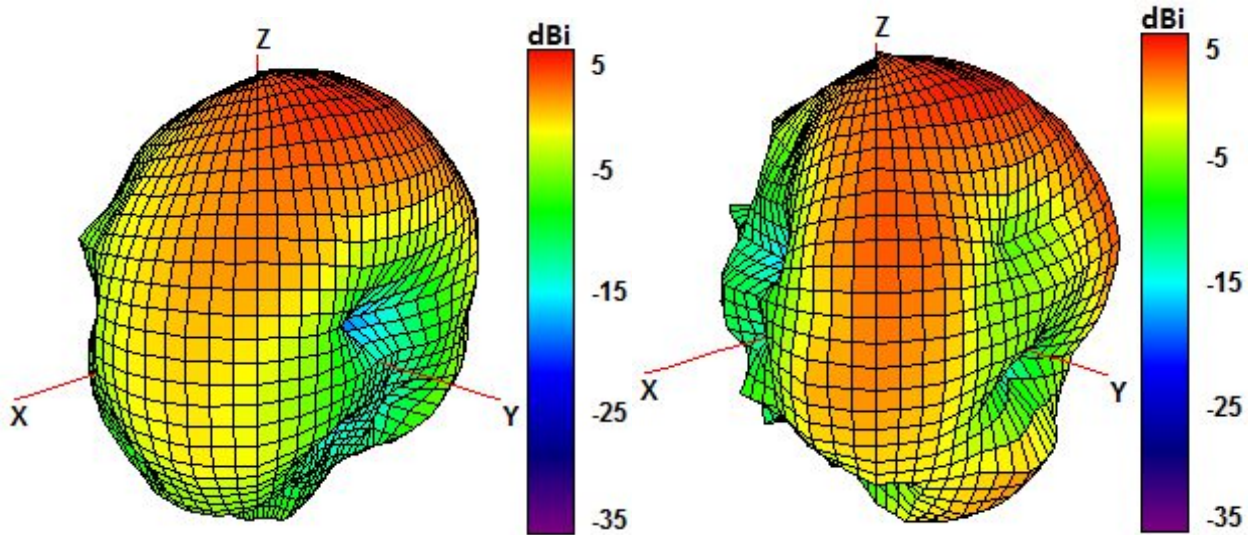

2100 and 2600 MHz Radiation pattern

Cable 3: CELLULAR/LTE

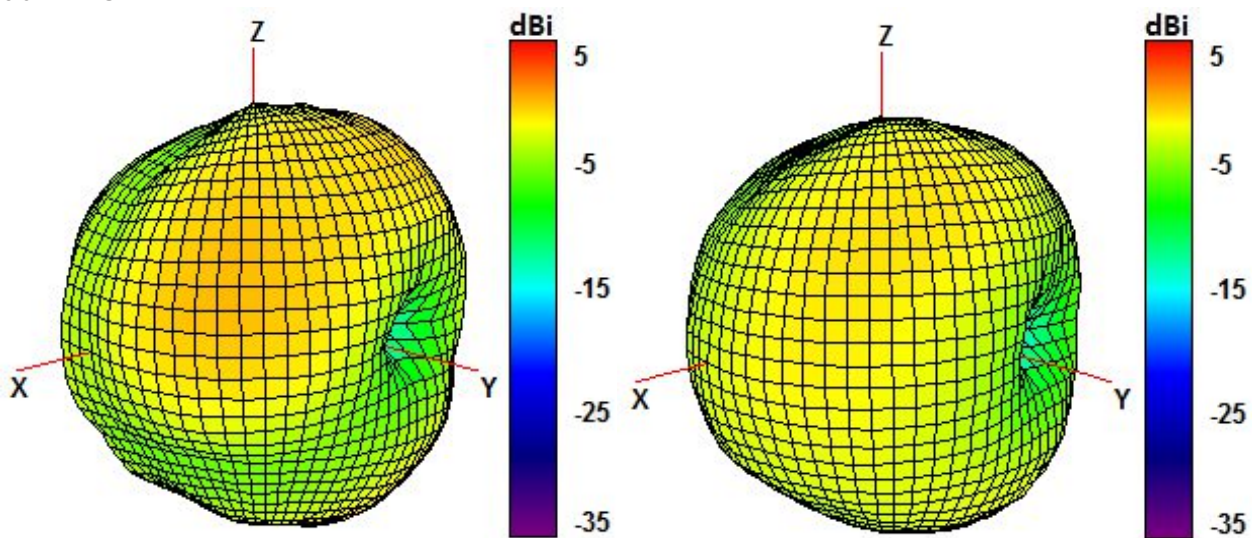

750 and 850 MHz Radiation pattern

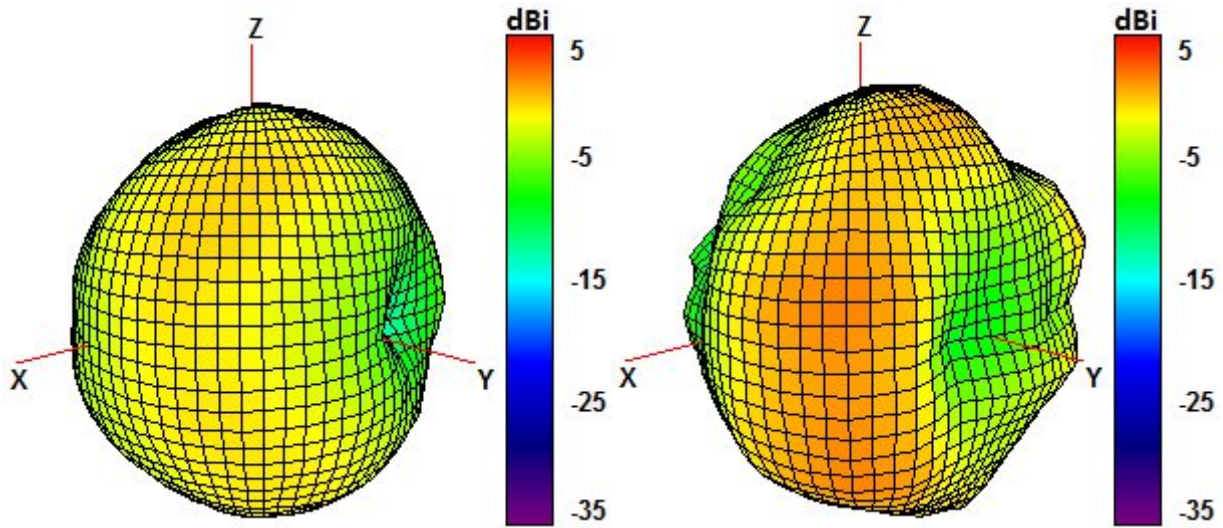

940 and 1750 MHz Radiation pattern

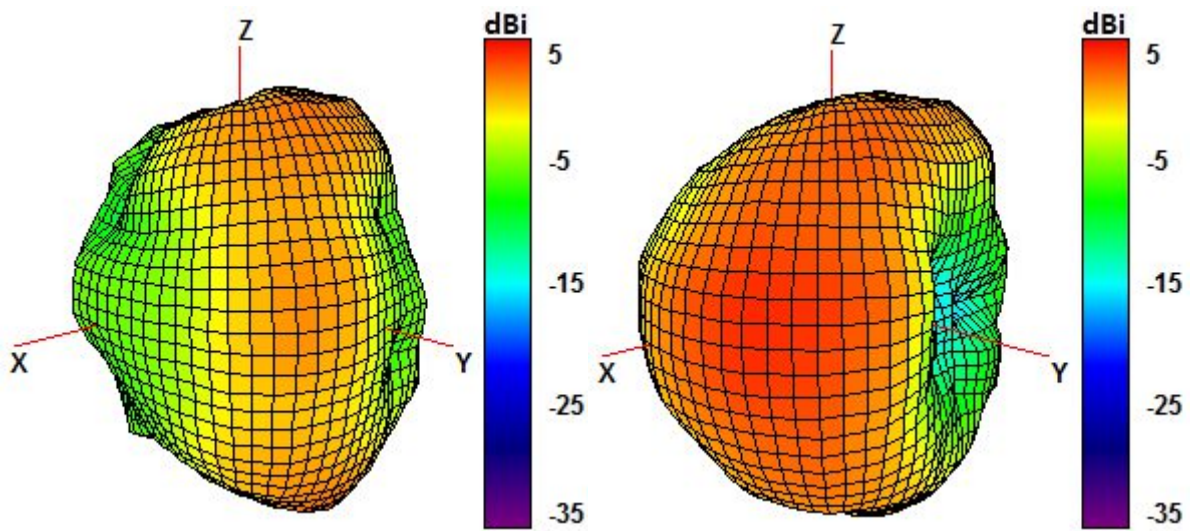

1850 and 1950 MHz Radiation pattern

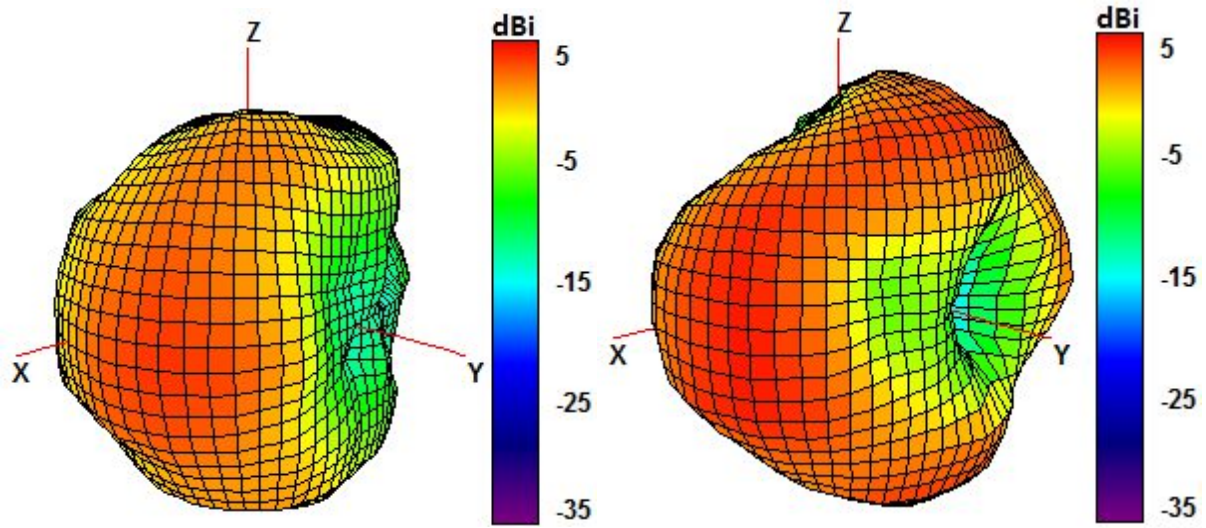

2100 and 2600 MHz Radiation pattern

Table 4: CELLULAR/LTE

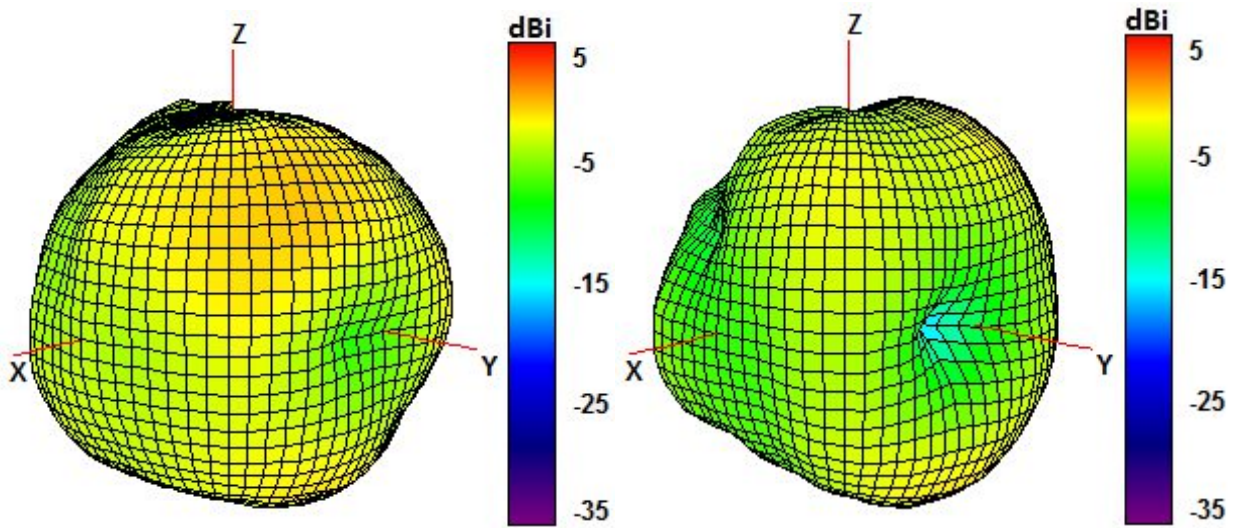

750 and 850 MHz Radiation pattern

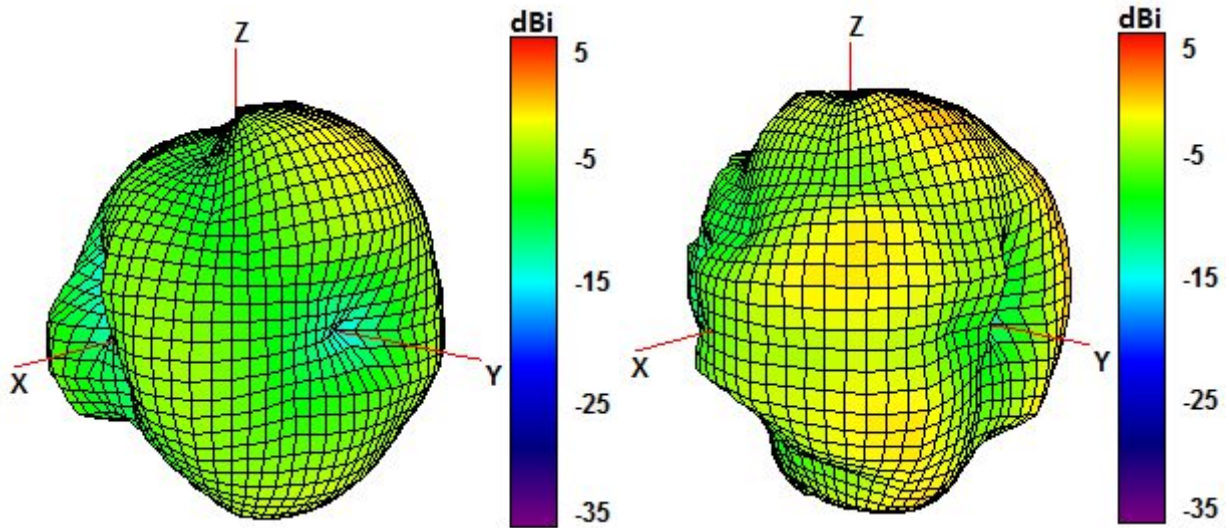

940 and 1750 MHz Radiation pattern

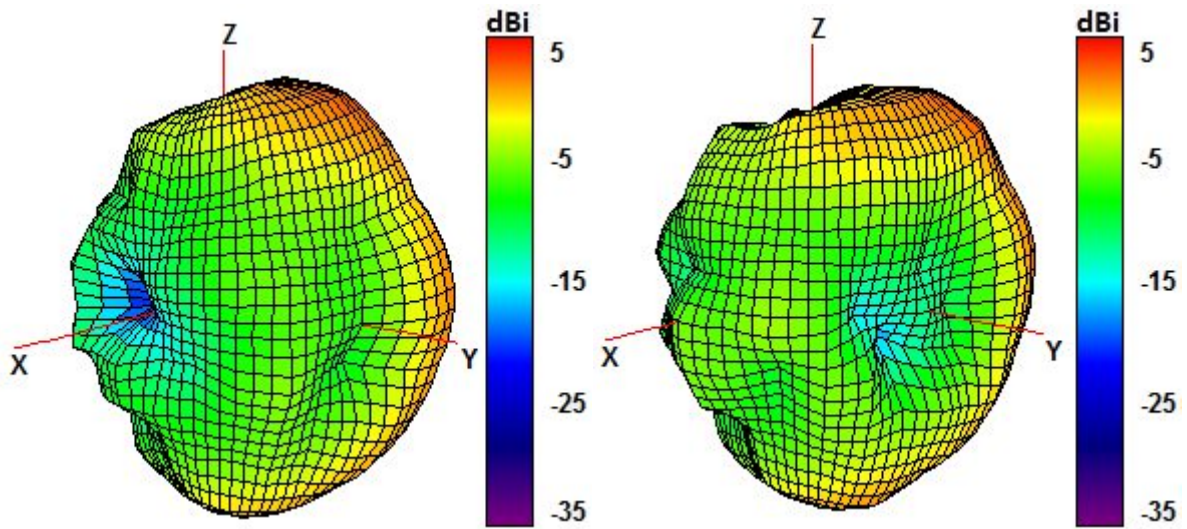

1850 and 1950 MHz Radiation pattern

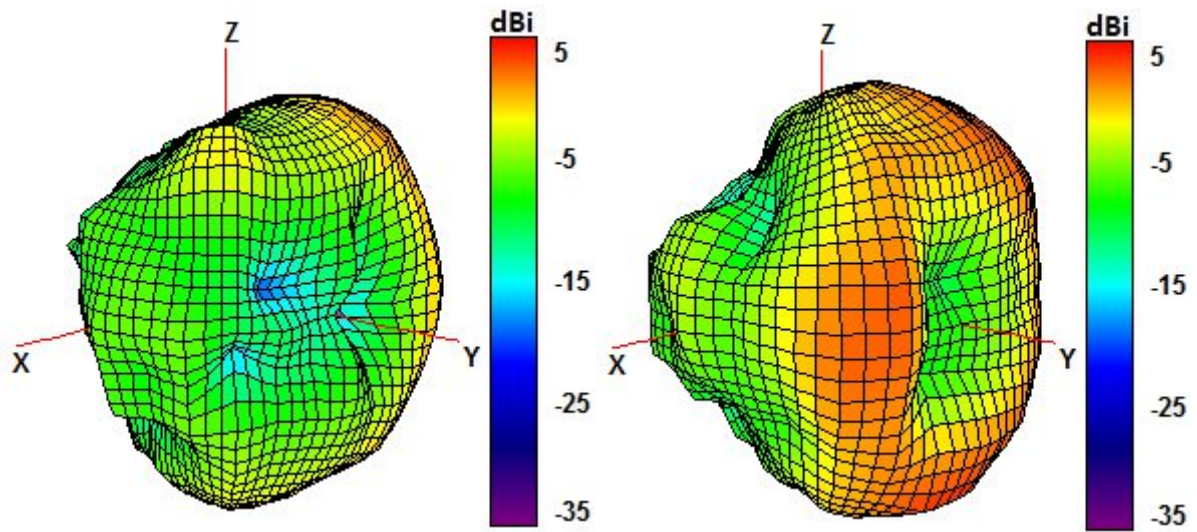

2100 and 2600 MHz Radiation pattern

4. Antenna drawings

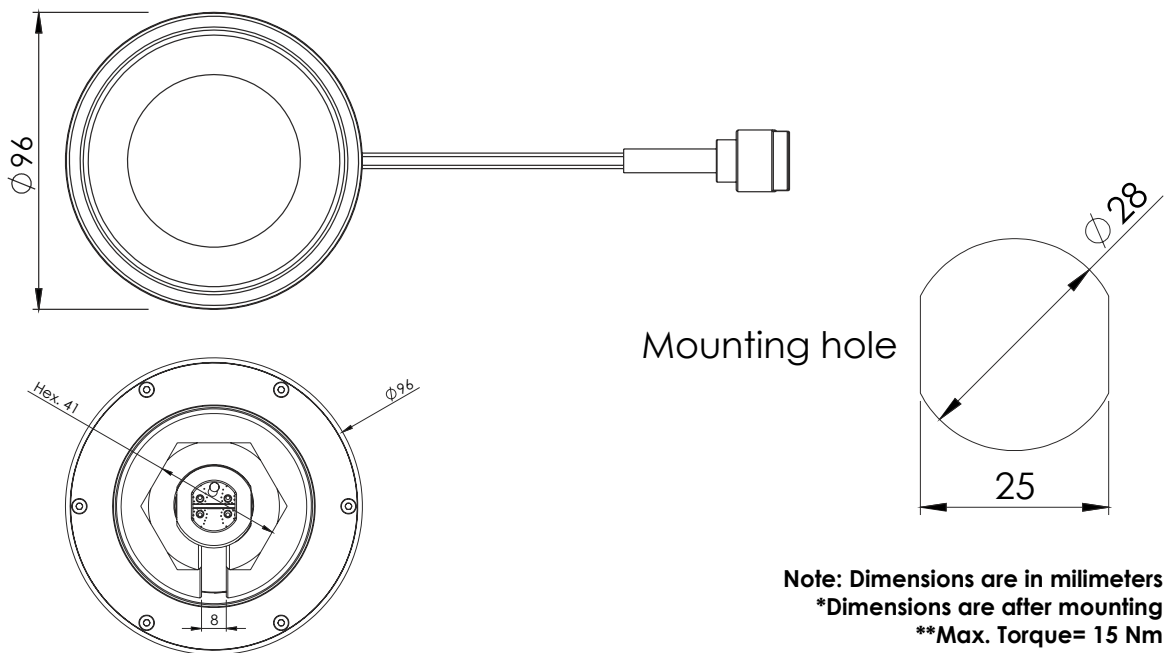
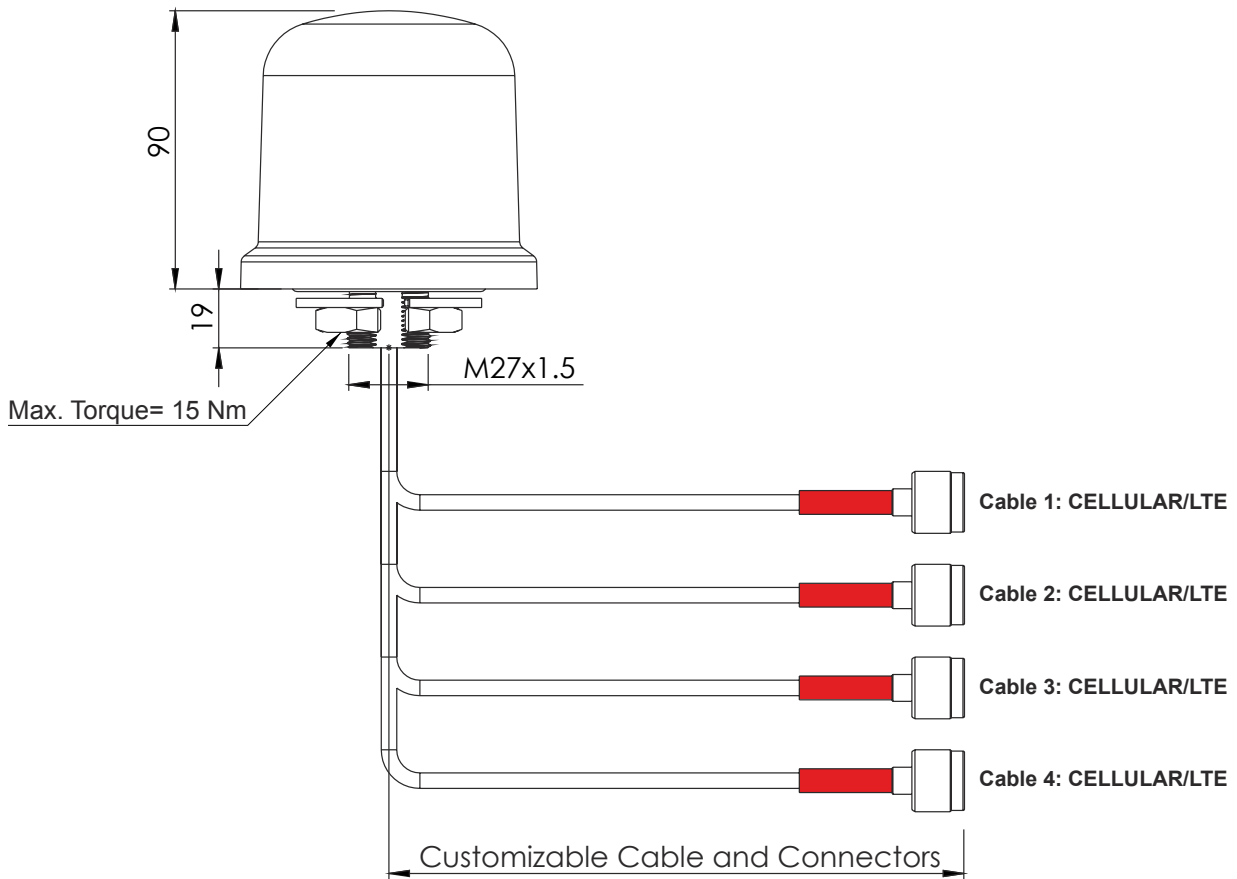

5. Jumper cables drawings - Optional

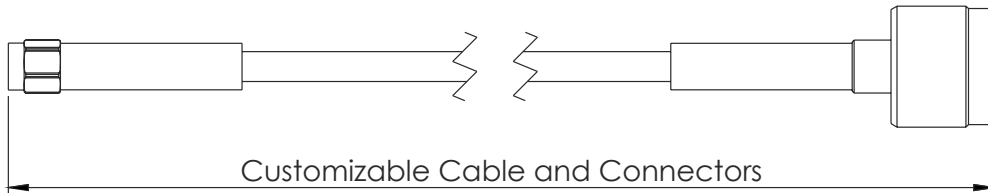

C318N-LMR195-C91N OST - 4x

Cable 1 - 4: CELLULAR/LTE - Shrink tube Orange d6,4

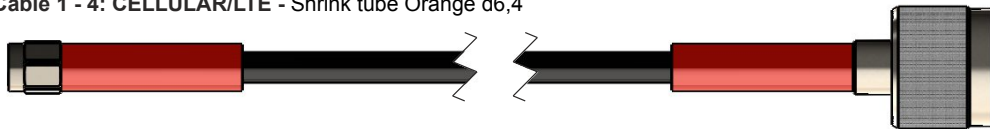

5. Antenna Images

