

2J4824P

Cellular/LTE Adhesive Mount

Key Features

Cable 1: CELLULAR/LTE

- 698-960 MHz
- 1710-2170 MHz
- 2500-2700 MHz

Adhesive Mount

Ground Plane Independent

Customizable Cable and Connector

Dimensions 83 x 35 x 13.3 mm

Certificates: IP67, IP69



Note: Antenna 2J4824PR equipped with 10K resistor for antenna detection is available.



1. Antenna and electrical specifications

Cable 1

Parameters	CELLULAR/LTE Antenna		
Standards	2G, 3G and 4G LTE		
Band (MHz)	700/850/900	1700/1800/1900/2100	2600
Frequency (MHz)	698-960	1710-2170	2500-2700
Return Loss (dB)	~-13.1	~-16.7	~-11.6
VSWR	~1.9:1	~1.4:1	~1.8:1
Efficiency (%)	~59	~55	~31
Peak Gain (dBi)	~3.4	~2.1	~1.0
Average Gain (dB)	~-2.3	~-2.5	~-5.1
Impedance (Ohm)	50		
Polarisation	Linear		
Radiation Pattern	Omni-Directional		
Max. Input Power (W)	25		
Connector Type	SMA-Male Standard (Other Connectors Available)		
Cable Length	300 cm Standard (Any Cable Length Available)		
Cable Type	LMR100 Standard (Other Cables Available)		

Antenna Measurement Conditions:

Mounted on 30 x 30 x 0.25 cm ABS Plate

200 cm of Cable LMR100

Measured in Certified CTIA 3D Anechoic Chamber

2. Mechanical and environmental specifications

Specifications	2J4824P
Mounting Type	Adhesive Mount
Dimensions (mm)	83 x 35 x 13.3
Radome	ABS
Radome color	Black
Operating Temperature (C)	-40 to +85
Storage Temperature (C)	-40 to +85
Substance Compliance	RoHS
Certificates	IP67, IP69

3. Antenna parameters

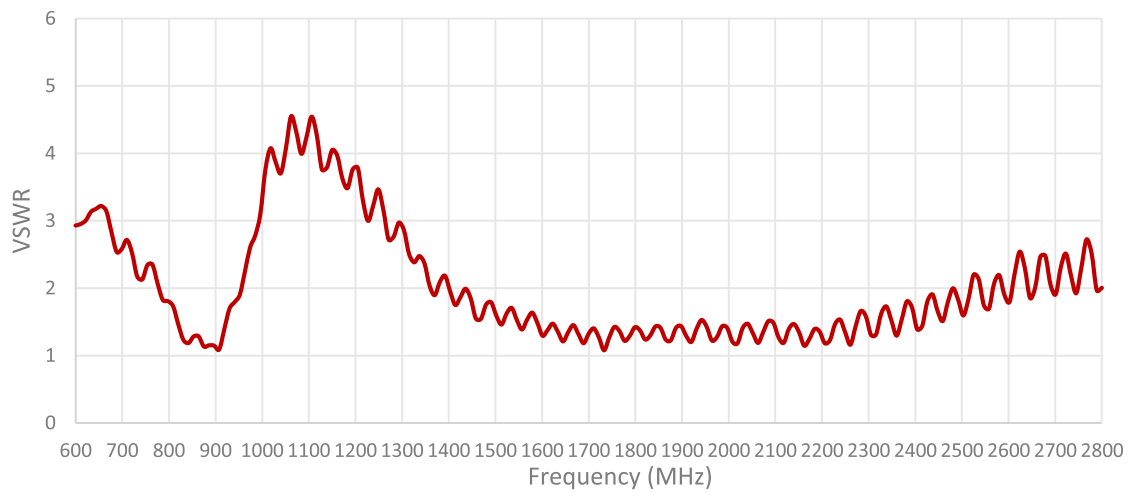
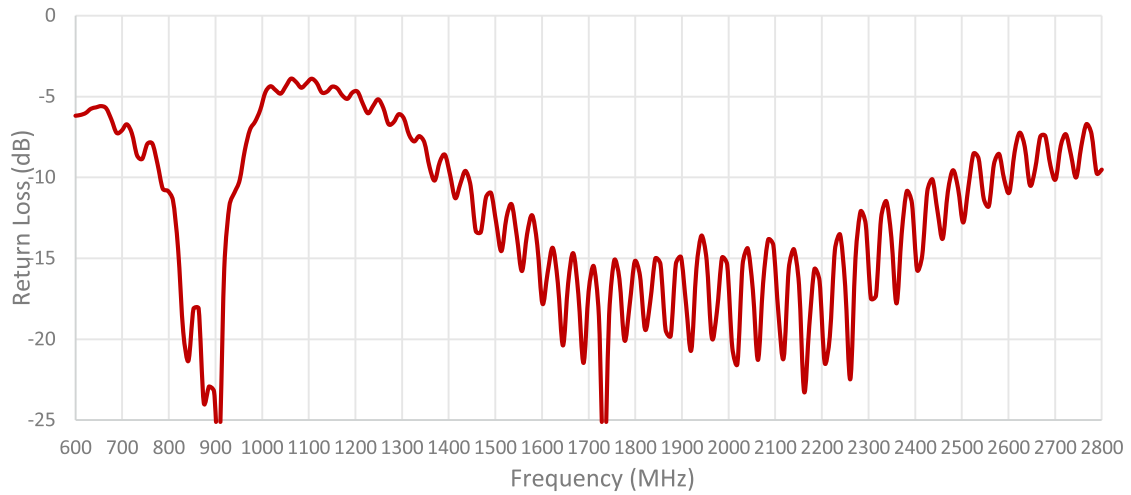

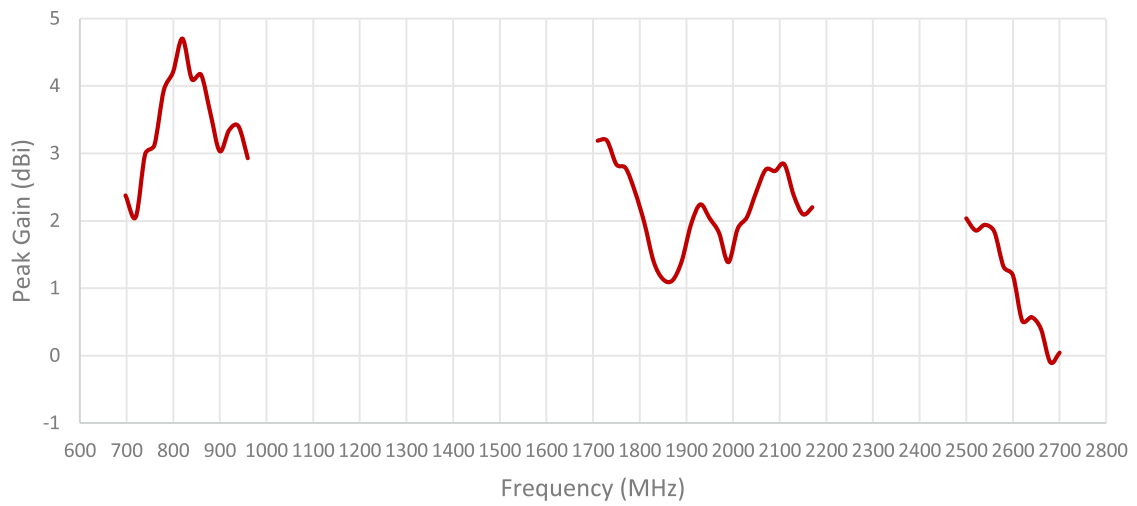
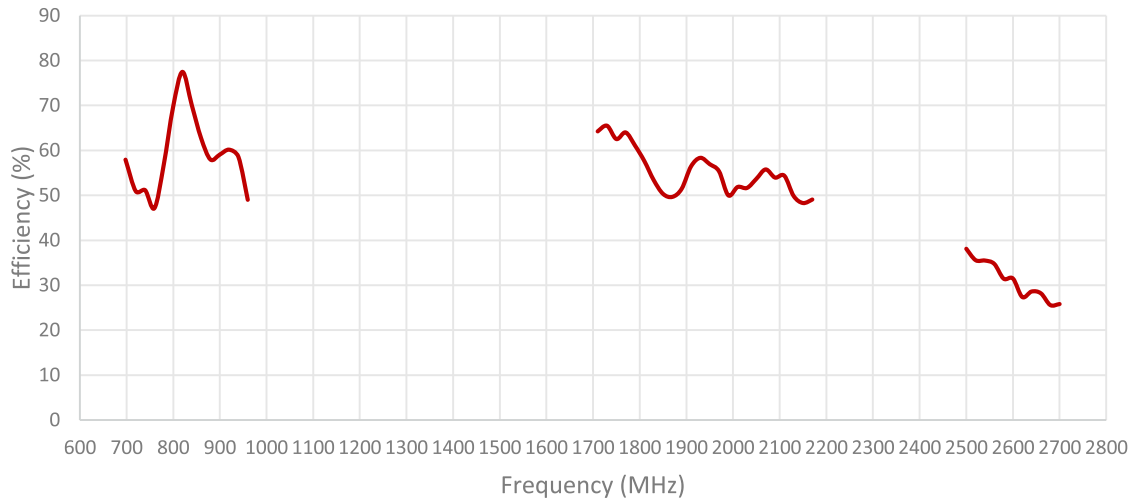

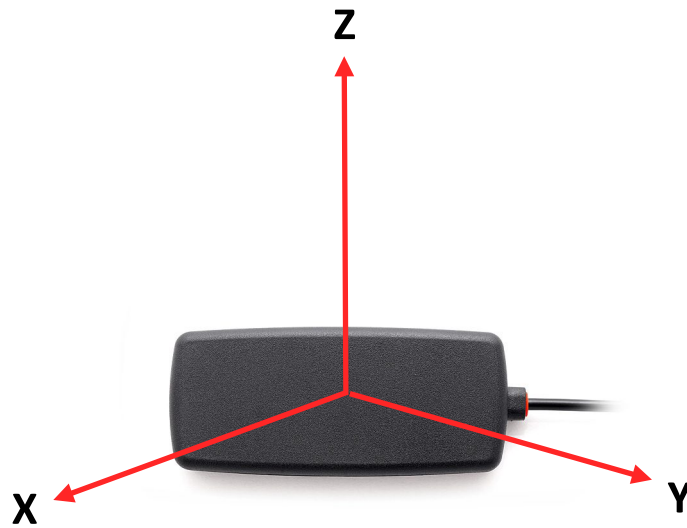
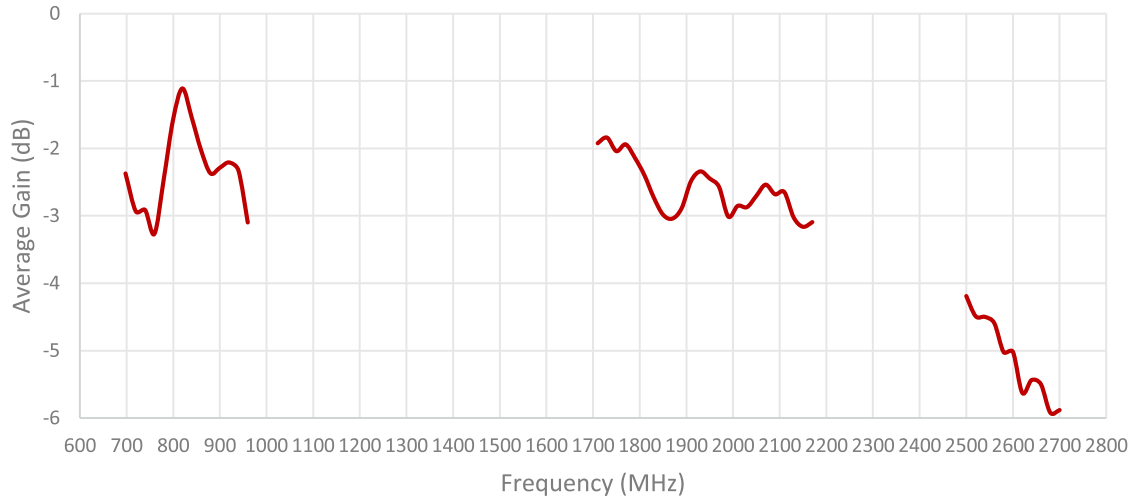

Radiation pattern reference

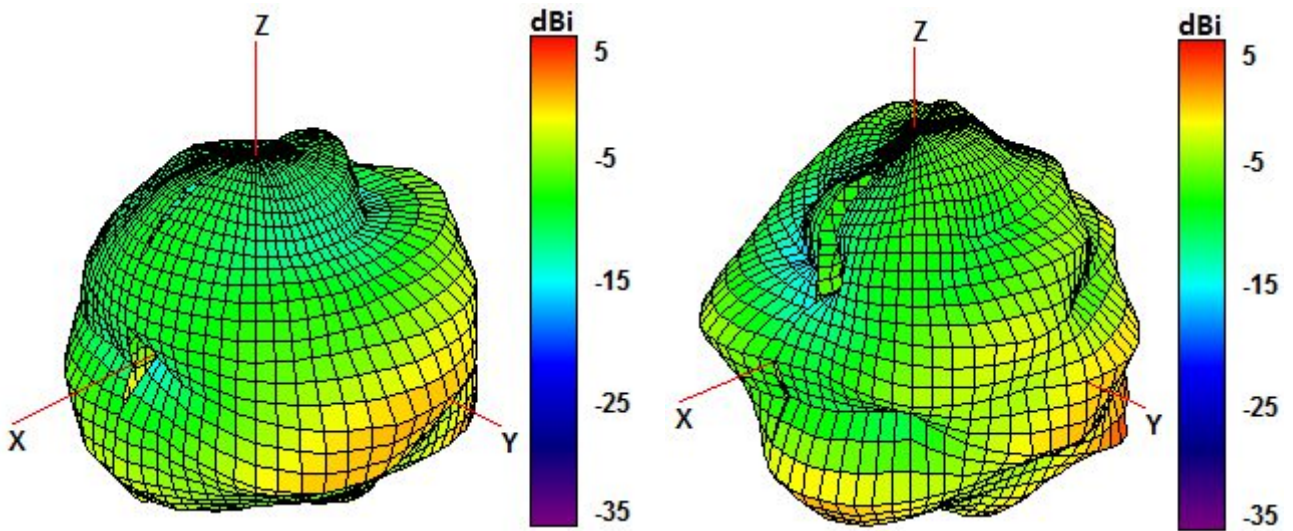

750 and 850 MHz Radiation pattern

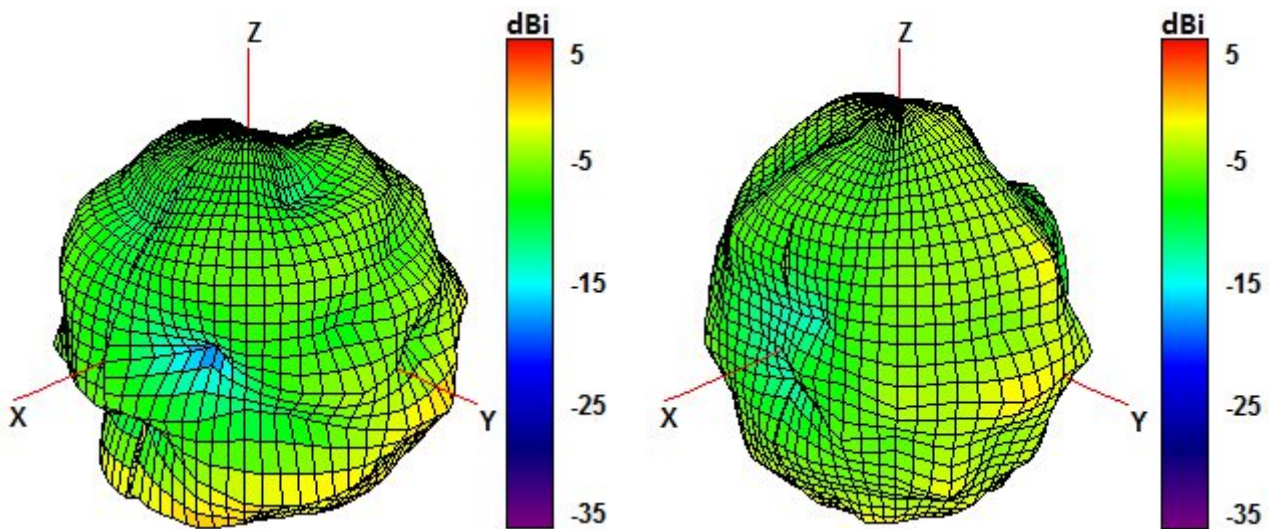

940 and 1750 MHz Radiation pattern

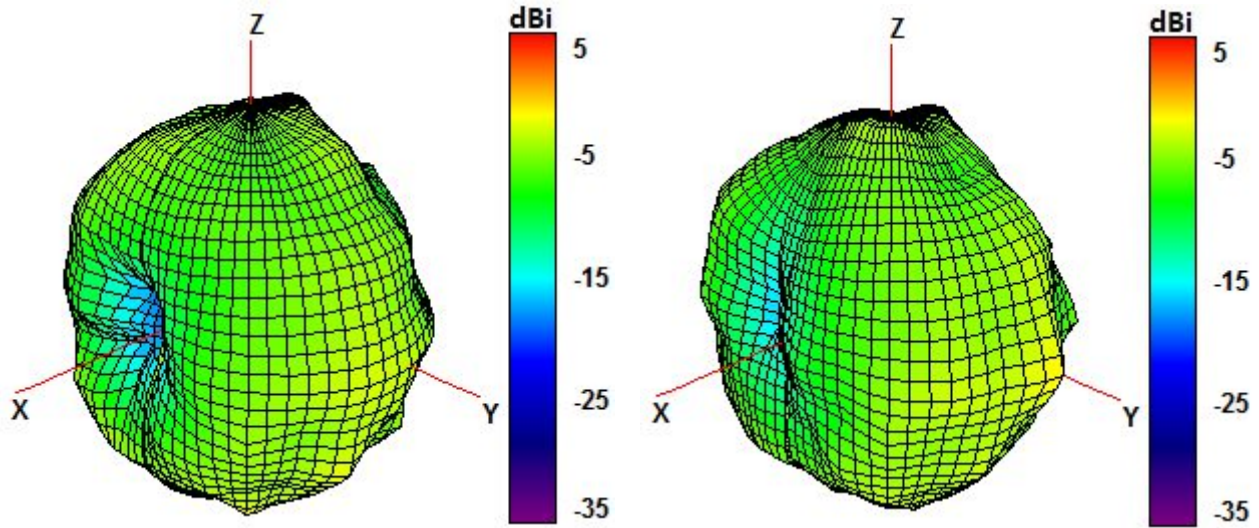

1850 and 1950 MHz Radiation pattern

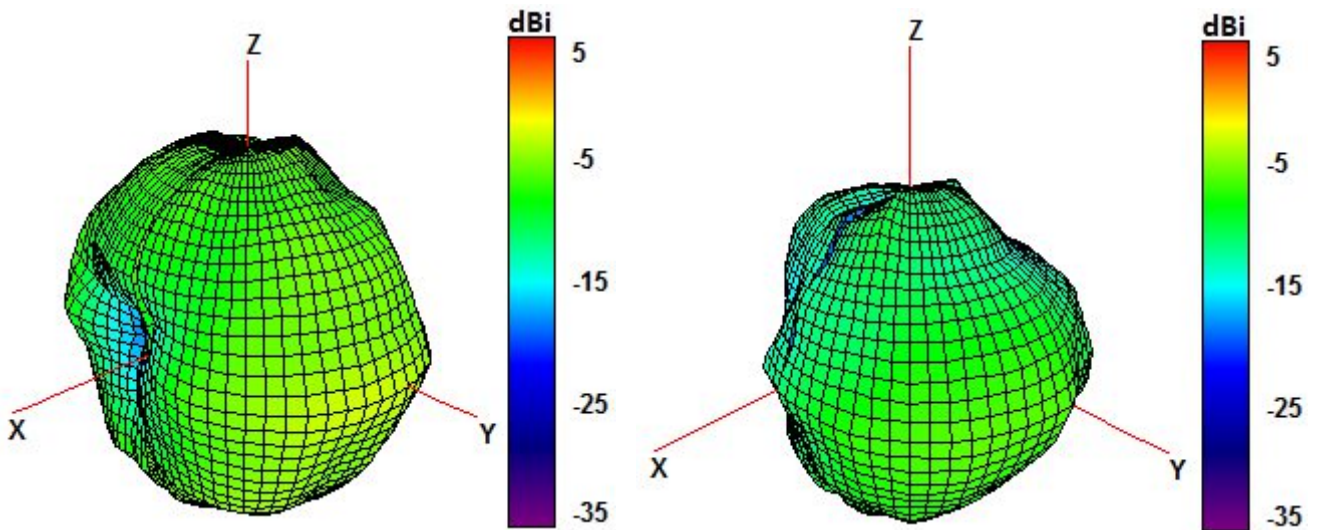

2100 and 2600 MHz Radiation pattern

4. Antenna drawings

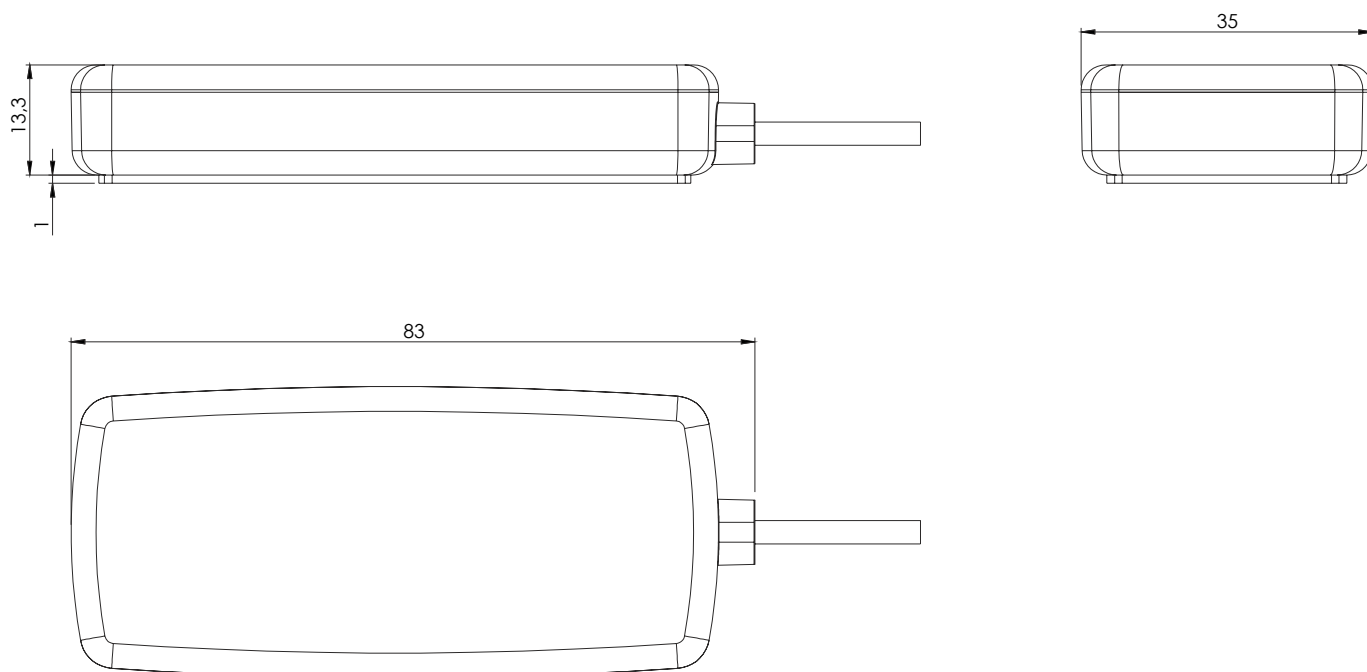

5. Antenna Images

