



MSTronic Co., Ltd.

2F, 12, Gongshang Rd., Wugu District, 248 New Taipei City, Taiwan

TEL:886-2-2293-0159 FAX:886-2-2292-8851

E.MAIL: mse@mse.com.tw

WEB: <http://www.mse.com.tw>

MIT-69G-1248BNNN

Gigabit PoE Injector

SPECIFICATION

1. INPUT :

- 1.1 Input Voltage: 10Vdc to 36Vdc
- 1.2 Input Current: 2.50A at 10Vdc
0.64A at 36Vdc

2. OUTPUT :

2.1 Output Voltage & Current:

OUTPUT	+48V
Max. load	0.42A
Power	20W
Min. Load	0A
Load reg. %	5%
Line reg. %	1%
Ripple %	1%
Noise %	1%

TOTAL POWER : 20W

Note 1: Noise bandwidth is from DC to 20Mhz. Ripple & Noise is measured by Paralleling a 0.1uF metalize capacitor on the test point.

3. EFFICIENCY : 72% min at Full Load , 10V ~ 36Vdc Input Voltage

4. PROTECTION

4.1 Short Circuit Protection

Output Short GND Terminal will not damage the Power Supply and will Auto-Reset.

4.2 Input with Fuse Protection.

4.3 Safety Standard: meet UL1950, CSA 22.2 & TUV EN60950.

4.4 EMC : meet FCC Class A, EN55032 Class A,

4.5 Over Current : 120% ~ 160% @12Vdc Input F.L

4.6 Dual Input Pin & Reverse Protection-----NO Work



MSTronic Co., Ltd.

2F, 12, Gongshang Rd., Wugu District, 248 New Taipei City, Taiwan

TEL:886-2-2293-0159 FAX:886-2-2292-8851

E.MAIL: mse@mse.com.tw
WEB: <http://www.mse.com.tw>

5. GENERAL DESCRIPTION

- 5.1 Operation Temperature: - 25C - +45C
- 5.2 Storage Temperature: -40C - +85C
- 5.3 Operation Humidity: 5% - 90%
- 5.4 Cooling: Free air cooling
- 5.5 Dimensions: Plastic case (MIT-69G-1248BNNN): 85*78*36 (L)*(W)*(H)

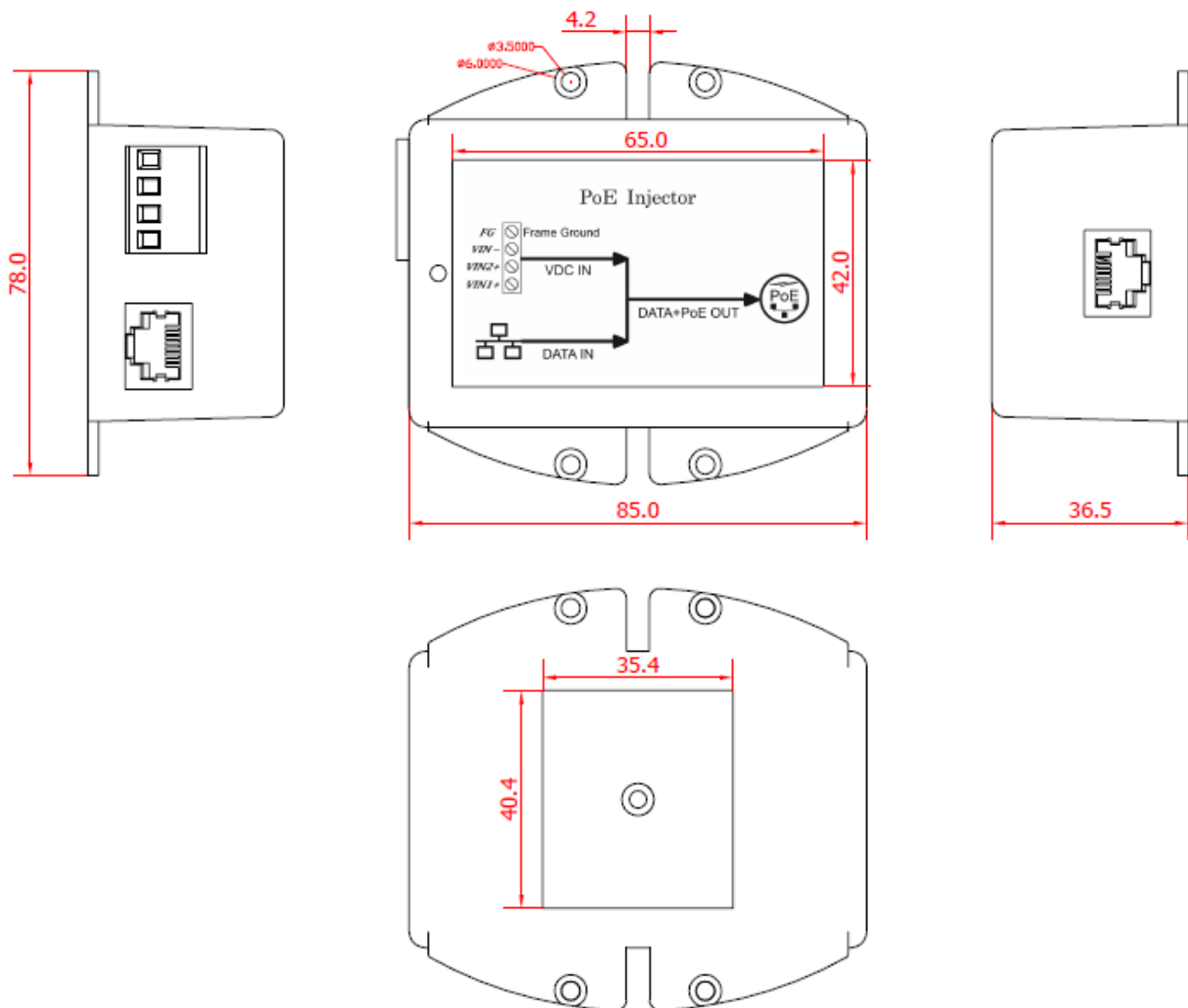

MIT-69G-1248BNNN



MSTronic Co., Ltd.

2F, 12, Gongshang Rd., Wugu District, 248 New Taipei City, Taiwan

TEL:886-2-2293-0159 FAX:886-2-2292-8851

E.MAIL: mse@mse.com.tw

WEB: <http://www.mse.com.tw>

6. Indicator :

6.1 Output OK the LED will be "GREEN"

7. RJ45 Connected and pin out: @1000MBASE

RJ-45 Input (Data Only)			RJ-45 Output (Data & Power)	
Pin	Symbol	Description	Symbol	Description
1	BI_DA+	Data Pair A+	BI_DA+	Data Pair A+
2	BI_DA-	Data Pair A-	BI_DA-	Data Pair A-
3	BI_DB+	Data Pair B+	BI_DB+	Data Pair B+
4	BI_DC+	Data Pair C+	+Vdc +BI_DC+	power(+)+Data Pair C+
5	BI_DC-	Data Pair C-	+Vdc +BI_DC-	power(+)+Data Pair C-
6	BI_DB-	Data Pair B-	BI_DB-	Data Pair B-
7	BI_DD+	Data Pair D+	-Vdc +BI_DB+	power(-)+Data Pair D+
8	BI_DD-	Data Pair D-	-Vdc +BI_DB-	power(-)+Data Pair D-

Note : the model is isolated design, the output +/- or input +/- can be shorted to ground (FG).

