

Rittal – The System.

Faster – better – everywhere.

CMC III CAN Bus Sensor



7030.100

Montage-, Installations- und Bedienungsanleitung
Assembly and operating instructions

ENCLOSURES

POWER DISTRIBUTION

CLIMATE CONTROL

IT INFRASTRUCTURE

SOFTWARE & SERVICES

FRIEDHELM LOH GROUP



Foreword

EN

Foreword

Dear Customer,

Thank you for choosing our CMC III CAN bus sensor (referred to hereafter as "CAN bus sensor")!

We wish you every success.

Yours

Rittal GmbH & Co. KG

Rittal GmbH & Co. KG
Auf dem Stützelberg

35745 Herborn
Germany

Tel.: +49(0)2772 505-0
Fax: +49(0)2772 505-2319

E-mail: info@rittal.com
www.rittal.com
www.rittal.de

We are always happy to answer any technical questions regarding our entire range of products.

Contents

1	Notes on documentation	4
1.1	CE labelling	4
1.2	Storing the documents	4
1.3	Symbols used in these operating instructions	4
1.4	Associated documents	4
2	Safety instructions	5
2.1	General safety instructions	5
2.2	Service and technical staff	5
3	Product description	6
3.1	Function description and components	6
3.1.1	Function	6
3.1.2	Components	6
3.2	Proper use, foreseeable misuse	6
3.3	Scope of supply	6
4	Transport and handling	7
4.1	Transport	7
4.2	Unpacking	7
5	Installation	8
5.1	Safety instructions	8
5.2	Siting location requirements	8
5.3	Installation procedure	8
5.3.1	Installation notes	8
5.3.2	Installation with the mounting bracket provided	8
5.3.3	Installation on a top-hat rail	8
5.4	Connecting the sensor	9
6	Operation	11
6.1	Activating the CAN bus sensor	11
6.2	Operating and display elements	11
6.3	LED displays	11
6.3.1	Multi-LED displays	11
6.3.2	LED displays on the CAN bus connection	11
6.4	Operating the CMC III Processing Unit from the website	11
6.4.1	Device	11
6.4.2	Input	11
7	Storage and disposal	14
7.1	Storage	14
7.2	Disposal	14
8	Technical specifications	15
9	Customer service addresses	16

1 Notes on documentation

1.1 CE labelling

Rittal GmbH & Co. KG hereby confirms that the CMC III CAN bus sensor is compliant with the EC EMC Directive 2004/108/EC. An appropriate declaration of conformity has been prepared. It can be provided on request.



1.2 Storing the documents

The operating, installation and maintenance instructions as well as all applicable documents are an integral part of the product. They must be passed to those persons who are engaged with the unit and must always be available and on hand for the operating and maintenance personnel.

1.3 Symbols used in these operating instructions

The following symbols are used in this documentation:



Danger!

A dangerous situation in which failure to comply with the instructions causes death or severe injury.



Warning!

A hazardous situation which may lead to death or serious injury if the instructions are not followed.



Caution!

A hazardous situation which may lead to (minor) injuries if the instructions are not followed.



Note:

Identification of situations that can lead to material damage.

- This symbol indicates an "action point" and shows that you should perform an operation or procedure.

1.4 Associated documents

- Installation instructions and Short User's Guide
- CMC III Processing Unit/CMC III Processing Unit Compact assembly, installation and operating instructions
- Installation instructions and Short User's Guide for the connected accessories (e.g. motion detector 7320.570).

2 Safety instructions

2.1 General safety instructions

Please observe the subsequent general safety instructions for the installation and operation of the system:

- Use only original Rittal products or products recommended by Rittal in conjunction with the CAN bus sensor.
- Please do not make any changes to the CAN bus sensor that are not described in this manual or in the associated manuals.
- The operating reliability of the CAN bus sensor is only warranted in case of use as intended and according to the rules. The technical specifications and limit values stated must not be exceeded under any circumstances. In particular, this applies to the specified ambient temperature range and IP degree of protection.
- The CAN bus sensor may not be opened. The unit does not contain any parts that need servicing.
- The operation of the system in direct contact with water, aggressive materials or inflammable gases and vapours is prohibited.
- Other than these general safety instructions, ensure you also observe the specific safety instructions when the tasks described in the following chapters are performed.

2.2 Service and technical staff

- The mounting, installation, commissioning, maintenance and repair of this unit may only be performed by qualified mechanical and electro-technical trained personnel.
- Only properly instructed personnel may work on a unit while in operation.

3 Product description

EN

3 Product description

3.1 Function description and components

3.1.1 Function

The CAN bus sensor provides the capability to integrate a previous-generation CMC-TC sensor into the CMC III system. It provides the values measured by this sensor to the connected CMC III Processing Unit. The CAN bus sensor has an identification that allows it to be detected automatically by the CMC III Processing Unit.



Note:

In the following text the designation "CMC III Processing Unit" refers to both the "CMC III Processing Unit" and also the "CMC III Processing Unit Compact". All of the text passages which only apply for one of the two variants are labelled accordingly.

3.1.2 Components

The device consists of a compact plastic housing in RAL 7035 with a ventilated front in RAL 9005.

3.2 Proper use, foreseeable misuse

The CAN bus sensor is used only for the connection of a CMC-TC sensor and the integration of this sensor in the CMC III system. It may only be used together with the CMC III Processing Unit. Any other use is not permitted.

The unit is state of the art and built according to recognised safety regulations. Nevertheless, incorrect use may result in damage to or faults with the system and other material assets.

Consequently, the unit must only be used properly and in a technically sound condition! Any malfunctions which impair safety should be rectified immediately. Follow the operating instructions!

The intended use also includes the observance of the documentation provided and fulfilling the inspection and maintenance conditions.

Rittal GmbH & Co. KG is not liable for any damage which may result from failure to comply with the documentation provided. The same applies to failure to comply with the valid documentation for the accessories used.

Inappropriate use may result in danger. Inappropriate use includes:

- Use of impermissible tools.
- Improper operation.
- Improper rectification of malfunctions
- Use of accessories not approved by Rittal GmbH & Co. KG.

3.3 Scope of supply

- CAN bus sensor
- Accessories provided (fig. 1)
- Installation and Short User's Guide

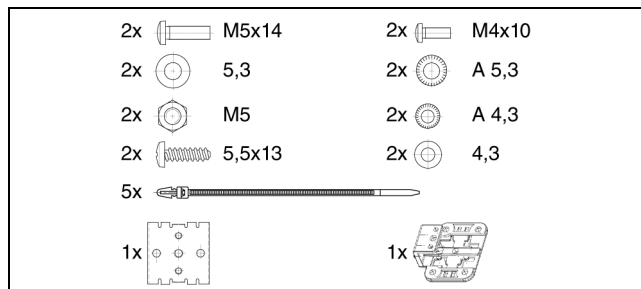

Fig. 1: Accessories provided

4 Transport and handling

4.1 Transport

The unit is delivered in a carton.

4.2 Unpacking

- Remove the unit's packaging materials.



Note:

After unpacking, the packaging materials must be disposed of in an environmentally friendly way. It consists of the following materials:

Polyethylene film (PE film), cardboard.

- Check the unit for any damage that occurred during transport.



Note:

Damage and other faults, e.g. incomplete delivery, should immediately be reported to the shipping company and to Rittal GmbH & Co. KG in writing.

- Remove the unit from the PE film.
- Remove the protective film from the front cover of the device.

5 Installation

5.1 Safety instructions

- Please observe the valid regulations for installation in the country in which the CAN bus sensor is installed and operated, and the national regulations for accident prevention. Please also observe any company-internal regulations, such as work, operating and safety regulations.
- The technical specifications and limit values stated may not be exceeded under any circumstances. In particular, this applies to the specified ambient temperature range and IP degree of protection.
- If a higher IP protection class is required for a special application, the CAN bus sensor must be installed in an appropriate housing or in an appropriate enclosure with the required IP degree of protection.

5.2 Siting location requirements

To ensure the correct function of the unit, the conditions for the installation site of the unit specified in section 8 "Technical specifications" must be observed.

Electromagnetic interference

- Interfering electrical installations (high frequency) should be avoided.

5.3 Installation procedure

There are two general options for installing the CAN bus sensor:

1. Installation on the frame of the enclosure or IT enclosure using the bracket included.
2. Installation on a top-hat rail using the bracket included along with a spring clip.

5.3.1 Installation notes

- The CAN bus sensor must be positioned so that it is ventilated with an adequate amount of air and the ventilation slots are not covered.

5.3.2 Installation with the mounting bracket provided

It can be mounted on the frame of the IT enclosure using the bracket included in the scope of delivery.

- Place the CAN bus sensor on the bracket from above.

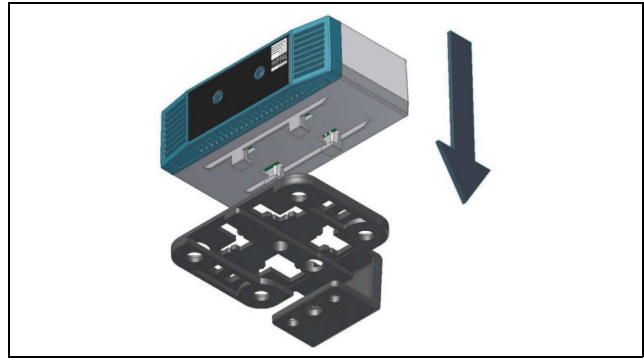

Fig. 2: Attaching the sensor to the bracket

- Move the sensor sideways slightly on the bracket, so that it latches into place.

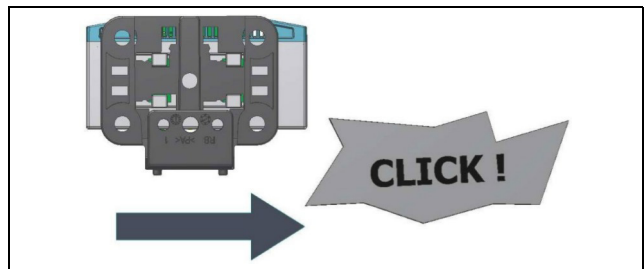

Fig. 3: Latching the sensor into place on the bracket

- Mount the bracket and the CAN bus sensor in the desired position in the enclosure or the IT enclosure using the screw included in the scope of delivery.

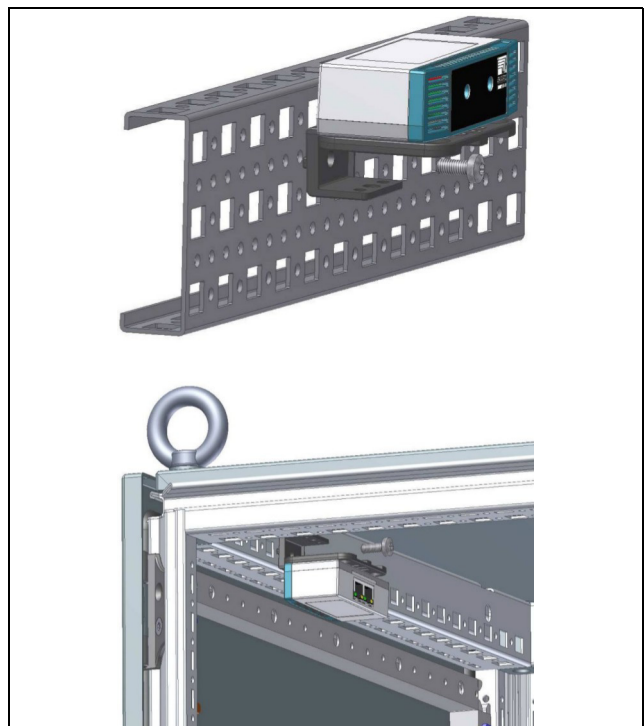

Fig. 4: Mounting the sensor in the enclosure or IT enclosure

5.3.3 Installation on a top-hat rail

The sensor can also be mounted on a top-hat rail using the bracket along with the spring clip included in the scope of delivery.

- First screw the bracket onto the spring clip provided for installation on a top-hat rail.

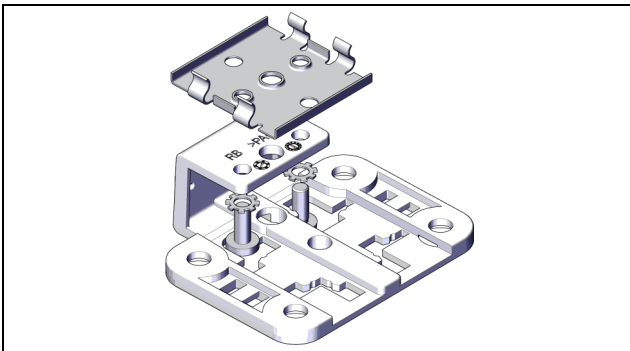

Fig. 5: Fastening the bracket to the spring clip

- Then place the CAN bus sensor on the bracket (fig. 2) and latch it in place (fig. 3).
- Latch the spring clip into place at the desired position on the top-hat rail.

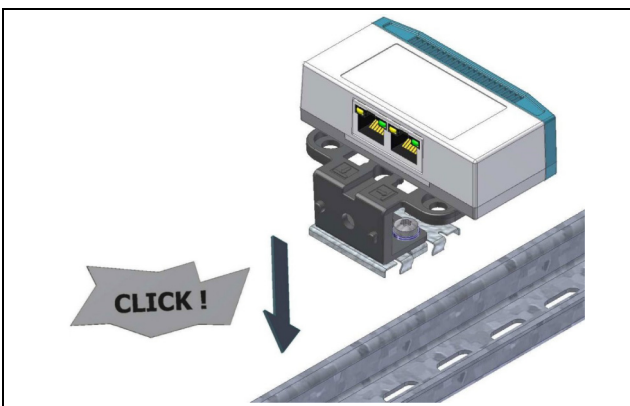

Fig. 6: Fastening the spring clip to the top-hat rail

5.4 Connecting the sensor

The CAN bus connection supplies the CAN bus sensor with the necessary operating voltage. A separate power supply unit does not need to be connected.

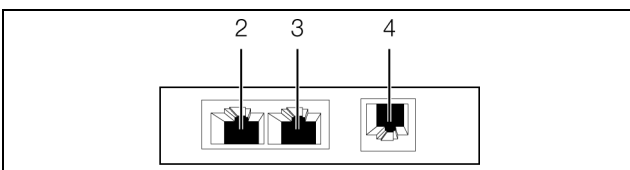

Fig. 7: Rear of the CAN bus sensor

Key

- 1 CAN bus connection, 24 V $\overline{\text{---}}$
- 2 CAN bus connection, 24 V $\overline{\text{---}}$
- 3 Connection for CMC TC sensor RJ 12

- Connect one of the following CMC TC sensors to the appropriate connection (fig. 7, item 4).
 - Temperature sensor (7320.500)
 - Analogue input 4-20 mA (7320.520)
 - Access sensor, max. 5 sensors in series supported, (7320.520)
 - Airflow sensor (7320.550)
 - Smoke detector (7320.560)
 - Motion detector (7320.570)
 - Digital sensor input (7320.580)

- Digital actuator output (7320.590)
- Voltage monitoring (7320.600)
- 48 V voltage sensor (7320.620)
- Leak sensor (7320.630)
- Leak sensor, 15 m sensory system (7320.631)
- Door Control Unit (7320.790)
- Fire alarm and extinguisher system DET-AC Plus – (7338.120)
- Early fire detection system EFD Plus (7338.220)
- Use a CAN bus connection cable to connect the CAN bus sensor to a CAN bus interface on the CMC III Processing Unit or of the neighbouring component on the CAN bus (fig. 7, item 2).

The following CAN bus connection cables from the CMC III accessories can be used:

- 7030.090 (length 0.5 m)
- 7030.091 (length 1 m)
- 7030.092 (length 1.5 m)
- 7030.093 (length 2 m)
- 7030.480 (length 3 m)
- 7030.490 (length 4 m)
- 7030.094 (length 5 m)
- 7030.095 (length 10 m)



Fig. 8: Front of the CAN bus sensor

Key

- 1 Multi-LED for status display

The sensor software is updated, if necessary, after being connected. The status LED of the CAN bus sensor glows blue throughout the entire update process and also flashes purple while the sensor itself is being updated. In addition, the status LED of the CMC III Processing Unit flashes white and a corresponding message appears on the website.



Note:

No settings can be modified as long as the update process is running.

The update of the sensor is complete when the following conditions have been fulfilled:

1. The LEDs on the CAN bus connection of the sensors light green.
2. The multi-LED of the sensor behind the front panel flashes blue and green, yellow or red, depending on the condition of the sensor.

Further components are connected as a daisy chain.

5 Installation

EN

- If necessary, connect another component (e.g. another sensor type) to the second, free CAN bus interface of the CAN bus sensor (fig. 7, item 3).

Status change display:

- The two green and the two red CAN bus LEDs on the CAN bus connection flash.
 - The multi-LED of the Processing Unit flashes continually in the sequence green – yellow – red.
 - The multi-LED of the CAN bus sensor flashes blue continuously.
- Press the "C" key on the CMC III Processing Unit (an initial audio signal will sound) and keep it pressed for approx. 3 seconds until a second audio signal is heard.



Note:

See section 6.3.1 "Multi-LED displays" for a list of all of the multi-LED displays.

Replacing the CMC TC sensor attached to the CAN bus sensor

- If the connected sensor is replaced with the same sensor type then the sensor is automatically identified. No confirmation is necessary.
 - If the connected sensor is replaced by a different type of sensor, the CAN bus sensor is de-registered and re-identified. This status change must be confirmed on the CMC III Processing Unit.
- To confirm, press the "C" key on the CMC III Processing Unit (an initial audio signal will sound) and keep it pressed for approx. 3 seconds until a second audio signal is heard.

6 Operation

6.1 Activating the CAN bus sensor

After connecting the CAN bus sensor to a neighbouring component using a CAN bus connecting cable, the CAN bus sensor starts automatically (see section 5.4 "Connecting the sensor"). Separate activation is not required.

6.2 Operating and display elements

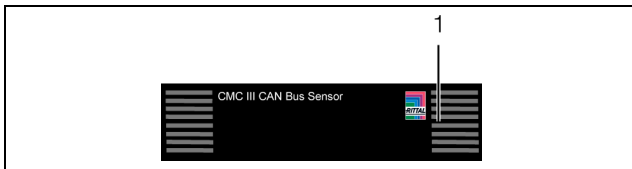

Fig. 9: Front of the CAN bus sensor

Key

- 1 Multi-LED for status display

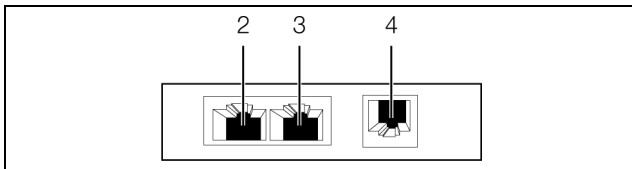

Fig. 10: Rear of the CAN bus sensor

Key

- 1 CAN bus connection, 24 V $\overline{\text{---}}$
 2 CAN bus connection, 24 V $\overline{\text{---}}$
 3 Connection for CMC TC sensor RJ 12

6.3 LED displays

A multi-LED for the status display is integrated into the front of the CAN bus sensor (fig. 9, item 1). Additional LEDs are located at the rear on the CAN bus connection (fig. 10, item 2 and item 3).

6.3.1 Multi-LED displays

The status of the CAN bus sensor can be read on the multi-LED.

Continuously lit

Colour	Status
Red	Invalid measured value

Tab. 1: Multi-LED continuously lit

Flashing codes

Colour	Status
Green	When the measured value changes or, at the latest, every 5 seconds.
Purple	A CAN bus sensor software update is being carried out.
Blue	Communication via the CAN bus.

Tab. 2: Multi-LED flashing codes

6.3.2 LED displays on the CAN bus connection

A red and a green LED are located on the CAN bus connection. They display the status of the CAN bus.

Colour	Status
Green (continuously lit)	Communication via the CAN bus possible.
Red (flashing)	Transmission fault.

Tab. 3: LEDs for the CAN bus connection

6.4 Operating the CMC III Processing Unit from the website

After logging on to the CMC III Processing Unit, the web interface for operating the device is displayed.

- First select the "CMCIII-SEN" entry in the navigation area.

Similar to the CMC III Processing Unit, the **Configuration** tab can be used to individually configure the access rights for the CAN bus sensor (**Access Rights** button) and the alarm messages (**Alarm Configuration** button).

The **Observation** tab is used to configure all of the settings for the CAN bus sensor and the connected accessories. The "Device" level enables you to configure all of the general settings which apply to the CAN bus sensor. The parallel level depends on the sensor connected.

In the following sections 6.4.1 "Device" and 6.4.2 "Input", only those parameters which you can modify are described. There are also display values that provide information.

6.4.1 Device

General settings for the CAN bus sensor are configured at the "Device" level.

Parameter	Explanation
Description	Specific description of the CAN bus sensor.
Location	Installation location of the CAN bus sensor.

Tab. 4: Settings in the "Device" level

In addition, parameters that provide detailed information about the CAN bus sensor, such as the version of the deployed software and hardware, are also displayed. You should have such information available, in particular to enable rapid troubleshooting when requesting assistance from Rittal.

6.4.2 Input

When a sensor is connected to the CAN bus sensor, another level is displayed in addition to the "Device" level.

6 Operation

The settings for the sensor are configured on this level. The name of this level depends on the connected sensor type.

Parameter	Explanation
DescName	Specific description of the connected sensor.
Delay	Time delay after which the status message changes.

Tab. 5: Settings in the "Input" level

The following parameters are also displayed for the connected sensor:

Parameter	Explanation
Value	Current value of the sensor.
Status	Current status of the sensor, taking into account the delay value.

Tab. 6: Displays in the "Input" level

The individual sensors can have the following states:

Sensor \ Status	Value 0	Value 1
Access sensor (7320.530)	Open	Closed

Tab. 7: Sensors with the status display "Open/Closed"

Sensor \ Status	Value 0	Value 1
Airflow sensor (7320.550)	Alarm	OK
Smoke detector (7320.560)	Alarm	OK
Motion sensor (7320.570)	Alarm	OK
Voltage monitoring (7320.600)	Alarm	OK
48 V voltage sensor (7320.620)	Alarm	OK
Fire alarm and extinguisher system DET-AC Plus (7338.120)	Alarm	OK
Early fire detection system EFD Plus (7338.220)	Alarm	OK

Tab. 8: Sensors with the status display "Alarm/OK"

Sensor \ Status	Value 0	Value 1
Leakage sensor (7320.630)	OK	Alarm
Leakage sensor, 15 m sensory system (7320.631)	OK	Alarm

Tab. 9: Sensors with the status display "OK/Alarm"

Sensor \ Status	Value 0	Value 1
Digital actuator output (7320.590)	Off	On
Door control unit (7320.790)	Off	On

Tab. 10: Sensors with the status display "Off/On"

Temperature sensor (7320.500)

The following settings are configured on the "Input" level for the temperature sensor.

Parameter	Explanation
SetPtHigh-Alarm	Upper limit temperature for which an alarm message is issued when exceeded.
SetPtHigh-Warning	Upper limit temperature for which a warning message is issued when exceeded.
SetPtLow-Warning	Lower limit temperature for which a warning message is issued when fallen below.
SetPtLow-Alarm	Lower limit temperature for which an alarm message is issued when fallen below.
Hysteresis	The necessary percentage deviation for falling below or exceeding the limit temperature to trigger a status change (see the assembly, installation and operating instructions for the CMC III Processing Unit).

Tab. 11: Settings in the "Input" level

The following parameters are also displayed for the temperature sensor:

Parameter	Explanation
Value	Currently measured temperature value.
Status	Current status of the sensor, taking into account the hysteresis.

Tab. 12: Displays in the "Input" level



Note:

If the value "0" is entered for all limit values at the "Input" level, the status of the temperature sensor is always "OK".

Analogue input (7320.520)

The following settings are configured on the "Input" level for the analogue input.

Parameter	Explanation
SetPtHigh-Alarm	Upper limit for which an alarm message is issued when exceeded.
SetPtHigh-Warning	Upper limit for which a warning message is issued when exceeded.

Tab. 13: Settings in the "Input" level

Parameter	Explanation
SetPtLow-Warning	Lower limit for which a warning message is issued when fallen below.
SetPtLow-Alarm	Lower limit for which an alarm message is issued when fallen below.
Hysteresis	The necessary percentage deviation for falling below or exceeding the limit to trigger a status change (see the assembly, installation and operating instructions for the CMC III Processing Unit).

Tab. 13: Settings in the "Input" level

The following parameters are also displayed for the analogue input:

Parameter	Explanation
Value	Currently measured value.
Status	Current status of the analogue input taking into account the hysteresis.

Tab. 14: Displays in the "Input" level



Note:

If the value "0" is entered for all limit values at the "Input" level, the status of the analogue input is always "OK".

Digital sensor input (7320.580)

The following settings are configured on the "Input" level for the digital sensor input.

Parameter	Explanation
Delay	Time delay after which the status message changes.

Tab. 15: Settings in the "Input" level

The following parameters are also displayed for the digital sensor input:

Parameter	Explanation
Value	The current value of the input (0 or 1).
Status	The current status of the digital sensor input taking into account the delay value (0 = OK, 1 = Alarm for "Normally Open" or 0 = Alarm, 1 = OK for "Normally Closed").

Tab. 16: Displays in the "Input" level

7 Storage and disposal

EN

7 Storage and disposal

7.1 Storage

If the device is not used for a long period, Rittal recommends that it is disconnected from the mains power supply and protected from damp and dust.

7.2 Disposal

Since the CAN bus sensor consists mainly of the "housing" and "circuit board" parts, the device must be passed on to the electronic waste recycling system for disposal.

8 Technical specifications

Technical specifications		CAN bus sensor
Model no.		7030.100
W x H x D (mm)		110 x 30 x 40
Operating temperature range		0°C...+55°C
Storage temperature		-45°C...+85°C
Operating humidity range		5%...95% relative humidity, non-condensing
Protection category		IP 30 to IEC 60 529
Inputs and outputs	CAN bus (RJ 45)	2 x
	RJ 12 C (CMC TC Sensor)	1 x
Operation/signals	LED display	OK/Warning/Alarm/CAN bus status

Tab. 17: Technical specifications

9 Customer service addresses

EN

9 Customer service addresses

For technical queries, please contact:

Tel.: +49(0)2772 505-9052

E-mail: info@rittal.com

Homepage: www.rittal.com

For complaints or service requests, please contact:

Tel.: +49(0)2772 505-1855

E-mail: service@rittal.de

Rittal – The System.

Faster – better – everywhere.

- Enclosures
- Power Distribution
- Climate Control
- IT Infrastructure
- Software & Services

RITTAL GmbH & Co. KG
Postfach 1662 · D-35726 Herborn
Phone +49(0)2772 505-0 · Fax +49(0)2772 505-2319
E-mail: info@rittal.de · www.rittal.com

ENCLOSURES

POWER DISTRIBUTION

CLIMATE CONTROL

IT INFRASTRUCTURE

SOFTWARE & SERVICES



FRIEDHELM LOH GROUP